

AcraDyne[®]

A Division of AIMCO



HIGH CAPABILITY TOOLING

2019



AIMCO

For over 40 years AIMCO has been working with manufacturers around the world. We are the complete global source for all critical fastening and bolting solutions. AIMCO can effectively and swiftly meet your needs whether you're in Thailand fastening a 3 mm nut at 3 Nm, or in Tennessee, USA torquing the last lug nut. AIMCO provides the tools and solutions, on a global scale, that guarantee the success of your project. It is with great pride that AIMCO can say the products that we manufacture are **MADE IN THE USA.**

TABLE OF CONTENTS

CONTROLLED TOOLS

GEN IV ACE CONTROLLER PLATFORM	4
CONTROLLER SOFTWARE	11
GEN IV SMART ARM SYSTEM WITH PROCESS VISUALIZATION	12
1000 SERIES NUTRUNNERS	14
1000, 2000, & 5000 SERIES PISTOL GRIP NUTRUNNERS	16
2000, 3000, & 5000 SERIES ANGLE NUTRUNNERS	17
2000, 3000, & 5000 SERIES INLINE NUTRUNNERS	18
5000 SERIES FIXTURED NUTRUNNERS	19
TUBENUT NUTRUNNERS AND SPECIALTY GEARHEADS	20
HOLD & DRIVE NUTRUNNERS	21
MID-EXIT CABLE NUTRUNNERS	22
RIVET NUTRUNNERS	23
HT SERIES DC TOOLS	24
HT SERIES DC ANGLE TOOLS	25
HT SERIES DC DUAL LEVER TOOLS	26
HT SERIES NOSE EXTENSIONS AND GEARHEAD TOOLS	28
HT SERIES DC TOOL ACCESSORIES	29
DC TOOL / SPINDLE SELECTION GUIDE	30
CABLES AND ACCESSORIES	32
CORDLESS TOOLS	36
MULTIPLE NUTRUNNING SYSTEMS	39
AIMCO TOOL SPECIALS	40

POWER TOOLS

ACRADYNE HT SERIES PNEUMATIC TOOLS	41
ACRADYNE HT SERIES HIGH-SPEED PNEUMATIC TOOLS	42
ACRADYNE HT SERIES PNEUMATIC TOOL ACCESSORIES	43
ACRADYNE HT SERIES BATTERY TOOLS	44

TOOL SUPPORT SYSTEMS

AIR PREPARATION UNITS	45
GCI TORQUE REACTION ARMS	46

INDEX	48
-----------------	----

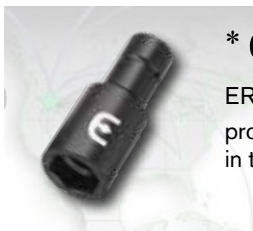

* **E** logo indicates where ERGO-DRIVE sockets/extensions benefit tool operation.

ERGO-DRIVE sockets are uniquely designed for repeatable, accurate rundowns. They also ensure excellent product quality, longer tool life, and better ergonomics for the tool user. Look for the ERGO-DRIVE **E** logo in this catalog to see where ERGO-DRIVE sockets/extensions benefit tool operation, operator, and rundown.

ACRADYNE GEN IV ACE CONTROLLER PLATFORM



AcraDyne's Gen IV ACE Controller platform is a single platform that commands all transducerized tools in the AIMCO portfolio

AIR | CORDLESS | ELECTRIC



The same, simple programming for all tool types, including:

AcraDyne

- DC Tools
- Cordless Battery Tools

Uryu

- Air Powered Tools
- Electric Tools

- No additional controller training needed for different platforms (tool type specific knowledge is required)
- One common communication for global data collection, line controls, and Field Bus platforms



ACRADYNE GEN IV ACE CONTROLLER PLATFORM

The Gen IV ACE controller platform provides ultimate **FLEXIBILITY** and **FREEDOM** to command tools for every application
One common communication for your global data collection, line controls, and Fieldus platforms.

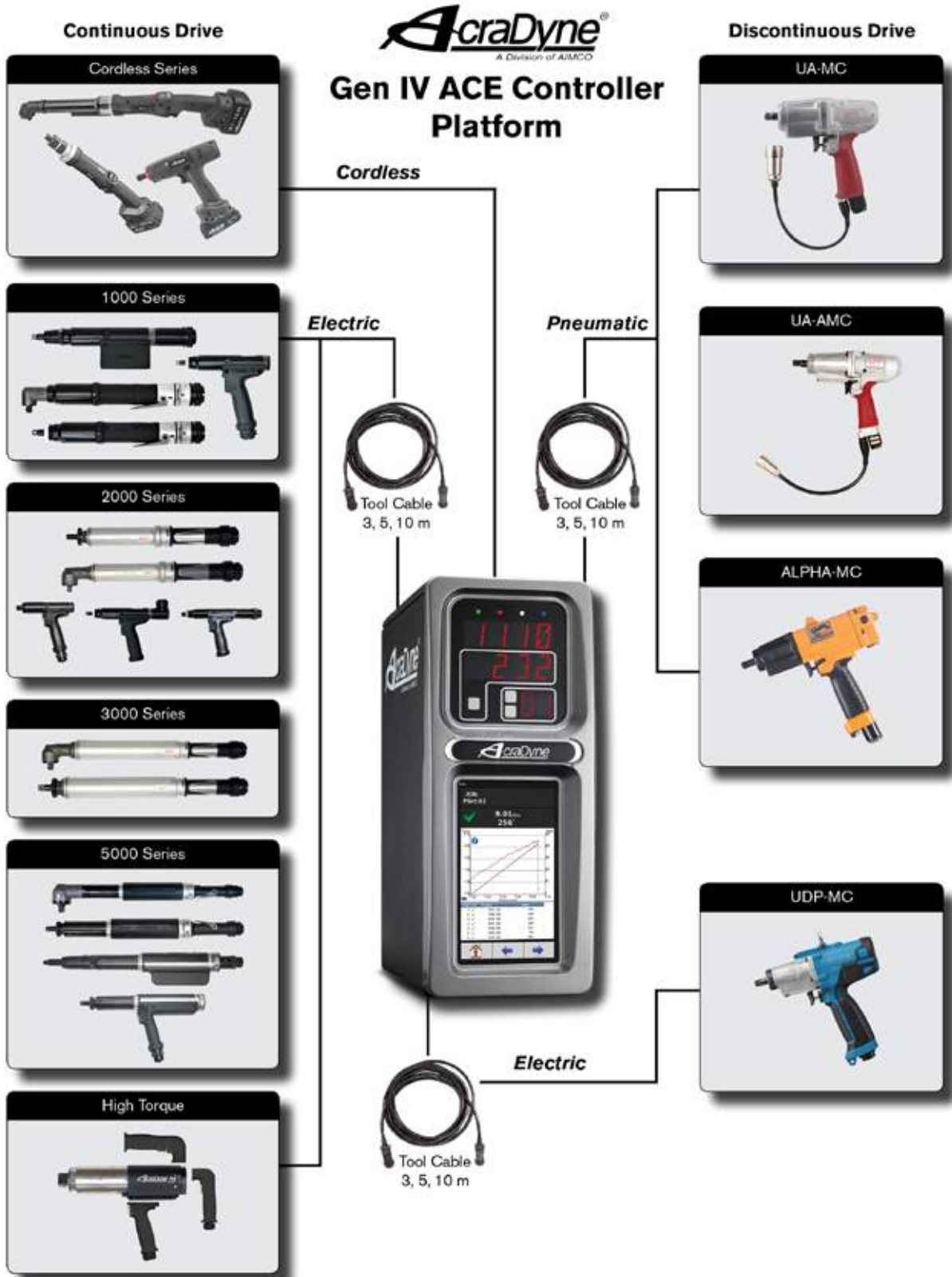

ACRADYNE GEN IV ACE CONTROLLER PLATFORM

The AcraDyne Gen IV ACE controller platform is the culmination of more than 40 years of serving our industrial fastening customers with 15 years of designing and manufacturing DC tools that are Made in the USA. It is filled with countless advanced capabilities and features. The Gen IV ACE Controller is the core of the modular AcraDyne DC system. One controller will command any tool in the AcraDyne line from 1 Nm to 12,000 Nm, all with one cable.



Four Digit LED Torque Display:
Large numbers can be seen from a distance.

Parameter Set Display:
Displays current parameter set and enables user to quickly change by scrolling up or down.

Secondary display allows user to easily set and toggle through information:

- Angle
- Engineering Units
- Bolt Count
- Job/Job Sequence

Optional 7" Touch-Screen Display:

- Runs the same software on PC for ease of use
- Real-Time Graphing
- Selectable Run Screens

FEATURES AND BENEFITS

- Web browser based programming – Receive data on your PC, tablet, smartphone, or any other web-capable device. You can use more than one device at a time: Be in program mode on one device while reviewing real-time curves on another, while watching tool diagnostics on a third
- Multiple fastening strategies – Program up to 256 parameters with as many as 20 steps
- Jobs capability – 99. Event log – 5,000
- Backup & restore through USB or Ethernet
- Assignable I/O (8 X 8)
- Rundown storage – 1,000,000
- Real-time curve viewing. Curve storage – 20,000

NETWORKING CAPABILITIES

- Ethernet Protocols supported: Open Protocol, ToolsNet, Ethernet/IP, Modbus TCP, PFCS, XML, FTP Client
-  Anybus® Field Bus connectivity: Profibus, Profinet, DeviceNet, CC-Link, CC-Link IE Field
- Data collection
- Serial protocols and string output
- Bar code scanning & printing
- Multi-spindle synchronization

ACRADYNE GEN IV ACE CONTROLLER PLATFORM

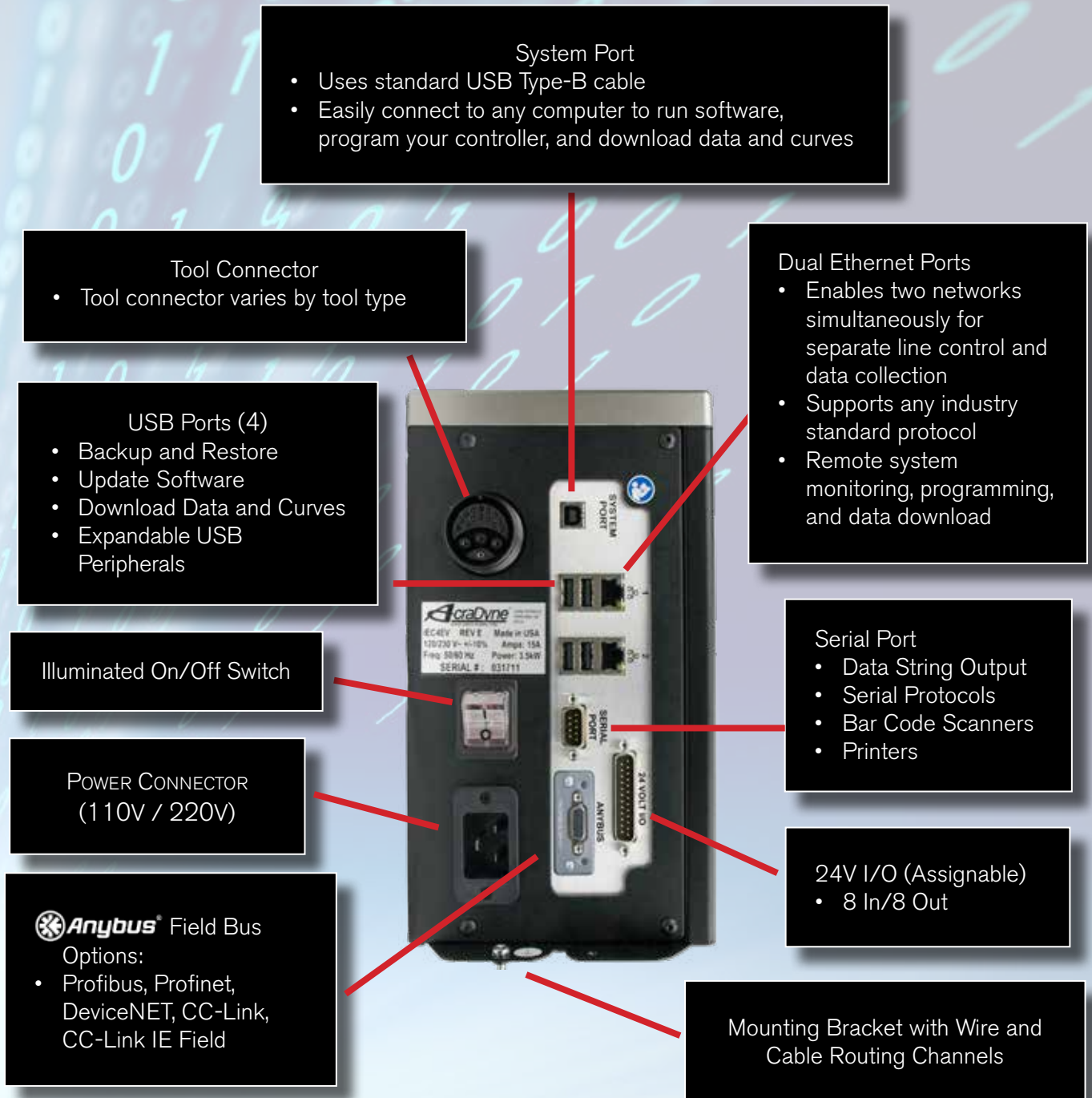

ACRADYNE GEN IV ACE CONTROLLER PLATFORM



GEN IV ACE iEC Controller for all AcraDyne DC Tools

MODEL*	SYSTEM PORT & REMOVABLE MEMORY	LIGHTS (L) LED DISPLAY (D) GRAPH (G)	24V I/O ASSIGNABLE 8 X 8"	SERIAL PORT WITH PROTOCOLS	BACKUP & RESTORE (USB)	ETHERNET** TWO PORTS
iEC4E	X	L/D		X	X	X
iEC4EV	X	L/D	X	X	X	X
iEC4EG	X	L/D/G		X	X	X
iEC4EGV	X	L/D/G	X	X	X	X

* Add (-T) to model number for top exit tool cable option.

For Field bus options add: P = Profibus, N = Profinet, D = DeviceNet, C = CC Link, M = CC-Link IE Field. Other Field bus options available upon request.

** Ethernet channel supports Open Protocol, ToolsNet, EtherNet/IP, Modbus TCP, PFCS, XML, and FTP Client.



GEN IV ACE iAC Controller for Transducerized Uryu Air Tools

MODEL*	SYSTEM PORT & REMOVABLE MEMORY	LIGHTS (L) LED DISPLAY (D) GRAPH (G)	24V I/O ASSIGNABLE 8 X 8"	SERIAL PORT WITH PROTOCOLS	BACKUP & RESTORE (USB)	SOLENOID SHUT OFF ON BOARD	PROGRAMMABLE REGULATOR ON BOARD	ETHERNET** TWO PORTS
iAC4E	X	L/D		X	X			X
iAC4EV	X	L/D	X	X	X			X
iAC4EG	X	L/D/G		X	X			X
iAC4EGV	X	L/D/G	X	X	X			X
iAC4ES	X	L/D		X	X	X		X
iAC4ESV	X	L/D	X	X	X	X		X
iAC4ESG	X	L/D/G		X	X	X		X
iAC4ESGV	X	L/D/G	X	X	X	X		X
iAC4ESR	X	L/D		X	X	X	X	X
iAC4ESRV	X	L/D	X	X	X	X	X	X
iAC4ESRG	X	L/D/G		X	X	X	X	X
iAC4ESRGV	X	L/D/G	X	X	X	X	X	X

* Add (-T) to model number for top exit tool cable option.

For Field bus options add: P = Profibus, N = Profinet, D = DeviceNet, C = CC Link, M = CC-Link IE Field. Other Field bus options available upon request.

** Ethernet channel supports Open Protocol, ToolsNet, EtherNet/IP, Modbus TCP, PFCS, XML, and FTP Client.

ACRADYNE GEN IV ACE CONTROLLER PLATFORM



GEN IV ACE iBC Controller for all AcraDyne Transducerized Battery Tools

MODEL*	SYSTEM PORT & REMOVABLE MEMORY	LIGHTS (L) LED DISPLAY (D) GRAPH (G)	24V I/O ASSIGNABLE 8 X 8"	SERIAL PORT WITH PROTOCOLS	BACKUP & RESTORE (USB)	ETHERNET** TWO PORTS
iBC4E	X	L/D		X	X	X
iBC4EV	X	L/D	X	X	X	X
iBC4EG	X	L/D/G		X	X	X
iBC4EGV	X	L/D/G	X	X	X	X

* For Zigbee option, add -Z to the end of the model number.

For Field bus options add: P = Profibus, N = Profinet, D = DeviceNet, C = CC Link, M = CC-Link IE Field. Other Field bus options available upon request.

** Ethernet channel supports Open Protocol, ToolsNet, EtherNet/IP, Modbus TCP, PFCS, XML, and FTP Client.



GEN IV ACE iPC Controller for Uryu UDP Transducerized DC Pulse Tools

MODEL*	SYSTEM PORT & REMOVABLE MEMORY	LIGHTS (L) LED DISPLAY (D) GRAPH (G)	24V I/O ASSIGNABLE 8 X 8"	SERIAL PORT WITH PROTOCOLS	BACKUP & RESTORE (USB)	ETHERNET** TWO PORTS
iPC4E(1)(2)	X	L/D		X	X	X
iPC4EV(1)(2)	X	L/D	X	X	X	X
iPC4EG(1)(2)	X	L/D/G		X	X	X
iPC4EGV(1)(2)	X	L/D/G	X	X	X	X

* Select (1) for 110V or (2) for 220V operation.

Add (-T) to model number for top exit tool cable option.

For Field bus options add: P = Profibus, N = Profinet, D = DeviceNet, C = CC Link, M = CC-Link IE Field. Other Field bus options available upon request.

** Ethernet channel supports Open Protocol, ToolsNet, EtherNet/IP, Modbus TCP, PFCS, XML, and FTP Client.

ACRADYNE GEN IV ACE CONTROLLER PLATFORM

NETWORK CONNECTIVITY



POKA-YOKE ERROR PROOFING

AcraDyne's Gen IV ACE Platform supports any third-party accessory to poka-yoke your process.

FEATURES AND BENEFITS

- 24V I/O inputs support the outputs of the receiver units
- Connect click wrenches, crimpers, or any poka-yoked device to your network data collection and line controls with all of the Ethernet protocols and Field Buses offered in the ACE Platform



ACRADYNE CONTROLLER SOFTWARE

SOFTWARE

AcraDyne's software package is on-board every AcraDyne controller and is provided FREE of charge. This comprehensive, user-friendly program allows programming, analysis, and diagnostics.

The software is based on a standard web browser, allowing you to connect the AcraDyne controller with any computer, tablet, or smart device. Connect through Ethernet, USB, or wirelessly via a network connected to both devices.

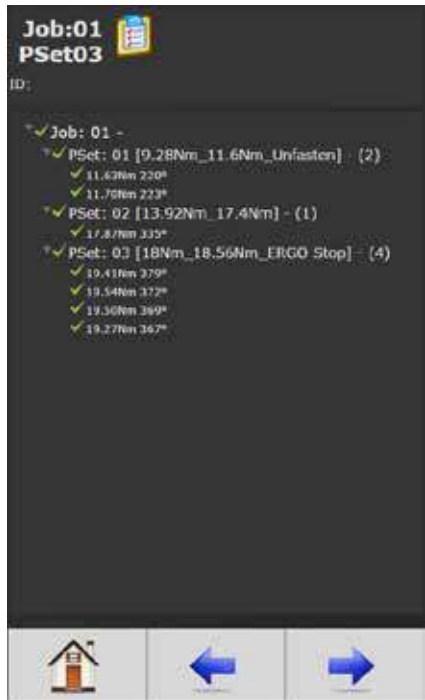

Adding and editing Parameter Sets (256) and Jobs (99) is easy and intuitive in the parameter set up function.



View curve results in real time or view stored results. As many as 20,000 curve results can be stored in memory.

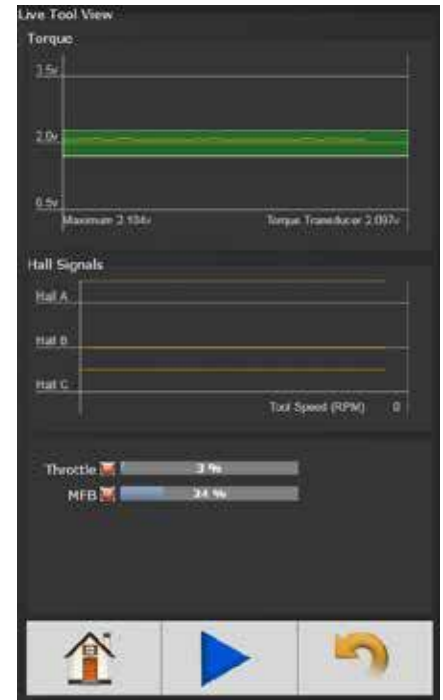

Tool programming and diagnostics for repair, calibration and advanced troubleshooting.



Choose from several run screens that display easy to view, large screen indicators.

GEN IV SMART ARM SYSTEM WITH PROCESS VISUALIZATION

Gen IV Controller with On-Board Smart Arm Capability and Process Visualization

AcraDyne Gen IV Controller's smart arm capability provides an advanced error-proofing solution to ensure the quality of your fastening operation. The process requires no external PC or software – the capability is on-board every Gen IV controller.

FEATURES AND BENEFITS

- Easy-to-follow visual guidance on the Gen IV controller graphical screen
- Easy setup – programming takes only minutes
- Once fastener locations are programmed into the Gen IV controller, the system can perform specific actions on specific fasteners
- No external PC or third-party software needed. Control the process using AcraDyne's Gen IV Controller and its integrated software, which is provided free of charge
- Low-cost solution vs. competitive offerings that require third-party PC-based control
- Modular – can be added at any time to an existing AcraDyne system using the Gen IV controller
- No guesswork! Powerful Gen IV data collection enables diagnostics and analysis
- Works with both continuous and discontinuous drive tools



The Gen IV controller provides easy-to-follow visual guidance directly on the graphical screen.

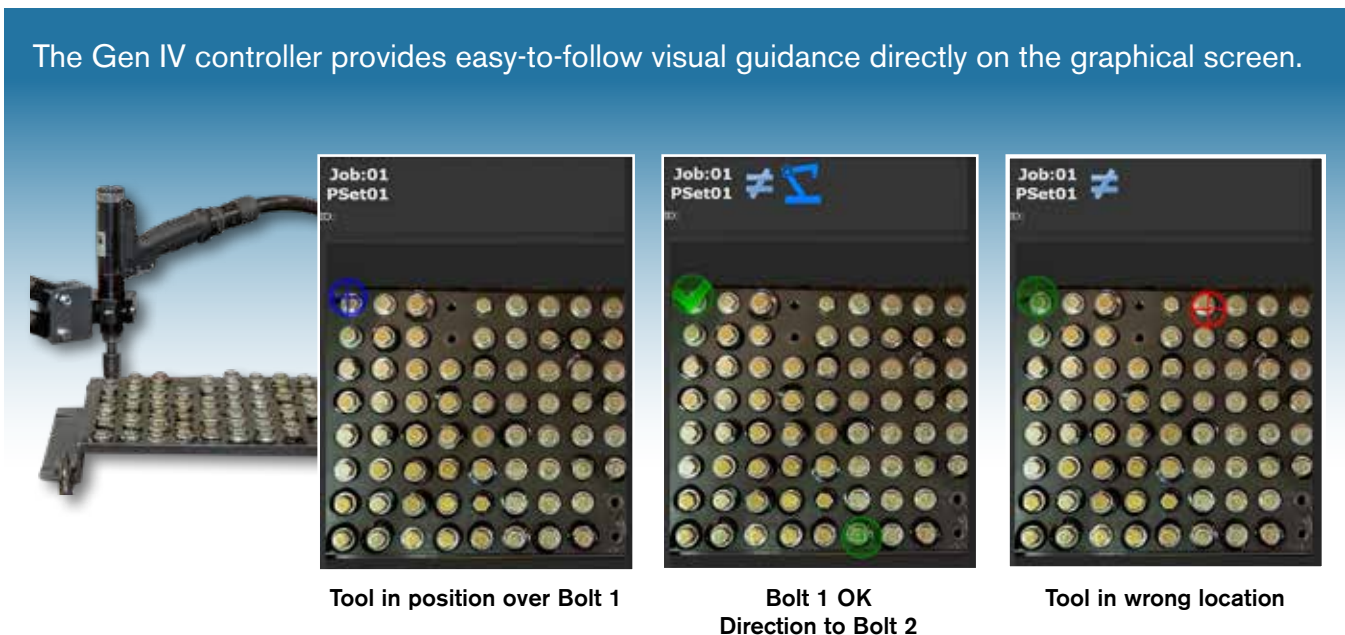

GEN IV SMART ARM SYSTEM WITH PROCESS VISUALIZATION

Smart Arm Accessory:

- Requires no external PC or third-party software for operation
- Gen IV Controller Software integrates with plant manufacturing execution software or allows custom programming

Encoders located at each joint of the arm.

Smart Arm guides operator in the specified torque pattern and counts fasteners required for correct assembly.

Gen IV Controller captures fastening-process data:

- Data captured and reported in real time with torque and graphing capabilities
- Curve results presented in real time or from stored results
- 20,000 curve results can be stored in memory
- Monitor, control, and report torque, angle, engineering units, fastener count, job/job sequence
- Multiple fastening strategies: 256 parameter sets with 20 stages
- Jobs capabilities – 99

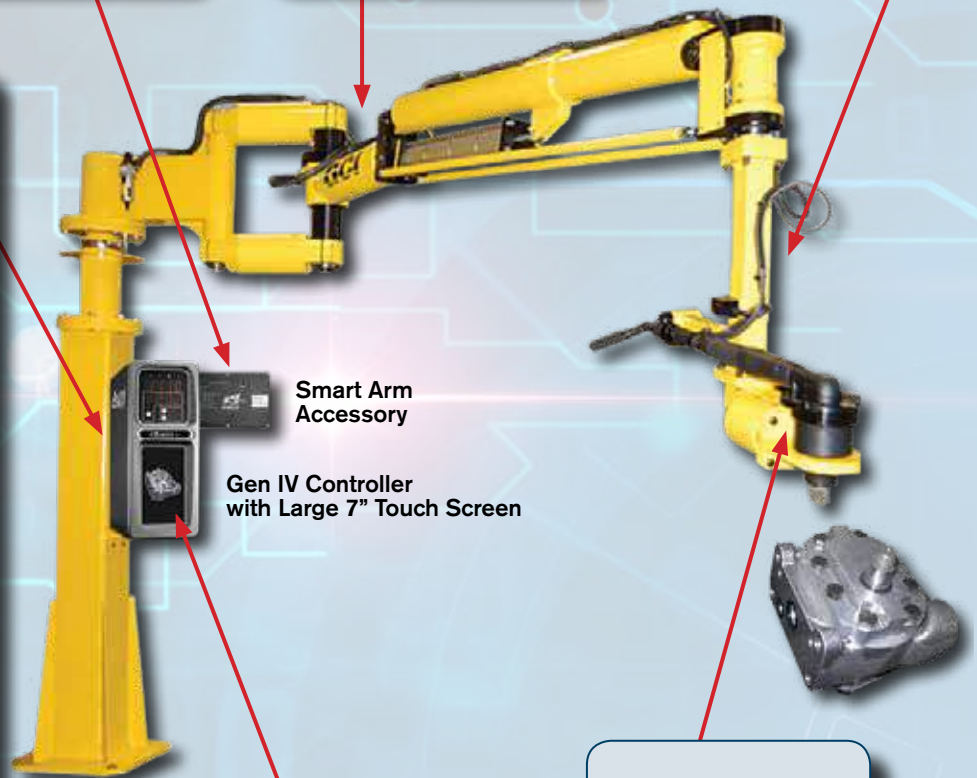

Custom image of run screen with preprogrammed fastener locations/specifications. Updates in real time.

Tool operates only when it is at the correct specified fastener location.

ACRADYNE 1000 SERIES NUTRUNNERS

FEATURES AND BENEFITS

Superior size, speed, and duty cycle



Angle



In-line



Push-to-Start



Fixtured
Rear Exit
Cable



Fixtured
Bottom Exit
Cable



APPLICATION DATA

1000 SERIES	NM	MAX TORQUE FT-LB	NM	TORQUE RANGE FT-LB	FREE SPEED RPM	LB	WEIGHT (-) SOCKET	KG	OUTPUT DRIVE
ANGLE*									
AEN4C12004B	4	3	1 - 4	0.7 - 3	3,111	2.0	0.91	1.00	3/8 sq. dr.
AEN4C12009B	9	6.6	2.3 - 9	1.7 - 6.6	1,750	2.2	1.00	1.00	3/8 sq. dr.
AEN4C12014B	14	10	3.5 - 14	2.6 - 10	875	2.2	1.00	1.00	3/8 sq. dr.
AEN4C12018B	18	13	4.5 - 18	3.3 - 13	691	2.2	1.00	1.00	3/8 sq. dr.
AEN4C12022B	22	16	5.5 - 22	4.1 - 16	560	2.2	1.00	1.00	3/8 sq. dr.
IN-LINE**									
AES4A12003B(V)(Q)	3	2.2	0.8 - 3	0.6 - 2.2	2,625	2.0	0.91	1.00	3/8 sq. dr.
AES4A12006B(V)(Q)	6	4.4	1.5 - 6	1.1 - 4.4	2,625	2.0	0.91	1.00	3/8 sq. dr.
AES4A12011B(V)(Q)	11	8.1	2.8 - 11	2 - 8.1	1,313	2.2	1.00	1.00	3/8 sq. dr.
AES4A12014B(V)(Q)	14	10	3.5 - 14	2.6 - 10	1,037	2.2	1.00	1.00	3/8 sq. dr.
AES4A12018BV	18	13	4.5 - 18	3.3 - 13	840	2.2	1.00	1.00	3/8 sq. dr.
AES4A12022BV	22	16	5.5 - 22	4.1 - 16	656	2.2	1.00	1.00	3/8 sq. dr.
PUSH-TO-START									
AEL4A12003B(Q)	3	2.2	0.8 - 3	0.6 - 2.2	2,625	2.0	0.91	1.00	3/8 sq. dr.
AEL4A12006B(Q)	6	4.4	1.5 - 6	1.1 - 4.4	2,625	2.0	0.91	1.00	3/8 sq. dr.
AEL4A12011B(Q)	11	8.1	2.8 - 11	2 - 8.1	1,313	2.2	1.00	1.00	3/8 sq. dr.
AEL4A12014B(Q)	14	10	3.5 - 14	2.6 - 10	1,037	2.2	1.00	1.00	3/8 sq. dr.
AEL4A12018B	18	13	4.5 - 18	3.3 - 13	840	2.2	1.00	1.00	3/8 sq. dr.
AEL4A12022B	22	16	5.5 - 22	4.1 - 16	656	2.2	1.00	1.00	3/8 sq. dr.
FIXTURED***									
AEF4(A)(C)(X)12003B(B)(Q)	3	2.2	0.8 - 3	0.6 - 2.2	2,625	2.0	0.91	1.00	3/8 sq. dr.
AEF4(A)(C)(X)12006B(B)(Q)	6	4.4	1.5 - 6	1.1 - 4.4	2,625	2.0	0.91	1.00	3/8 sq. dr.
AEF4(A)(C)(X)12011B(B)(Q)	11	8.1	2.8 - 11	2 - 8.1	1,313	2.2	1.00	1.00	3/8 sq. dr.
AEF4(A)(C)(X)12014B(B)(Q)	14	10	3.5 - 14	2.6 - 10	1,037	2.2	1.00	1.00	3/8 sq. dr.
AEF4(A)(C)(X)12018B(B)	18	13	4.5 - 18	3.3 - 13	840	2.2	1.00	1.00	3/8 sq. dr.
AEF4(A)(C)(X)12022B(B)	22	16	5.5 - 22	4.1 - 16	656	2.2	1.00	1.00	3/8 sq. dr.

* Add "F" to part numbers for flush socket.

** "V" indicates extended Ergo-Drive output  Replace "V" with "Q" for 1/4" quick change output.

*** Add "A" to part numbers for 1/2" sliding spindle models. Add "C" to part numbers for 1-3/4" sliding spindle models. Add "X" to part numbers for fixed 3/8" square drive output models.

*** Add "B" to part numbers for bottom exit cable.

*  logo indicates where ERGO-DRIVE sockets/extensions benefit tool operation.

ACRADYNE 1000 SERIES NUTRUNNERS

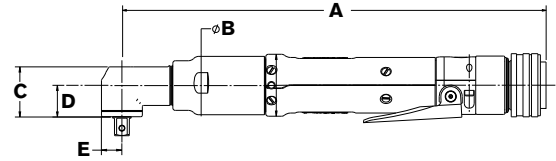

DIMENSIONS

ANGLE	IN	(A)	MM	IN	(B)	MM	IN	(C)	MM	IN	(D)	MM	IN	(E)	MM
AEN4C12004B	11.65		295.9	1.47		37.3	.98		24.8	.62		15.8	.40		10.2
AEN4C12009B	11.00		279.5	1.47		37.3	1.29		32.8	.82		20.9	.52		13.1
AEN4C12014B	11.66		296.4	1.47		37.3	1.29		32.8	.82		20.9	.52		13.1
AEN4C12018B	11.66		296.4	1.47		37.3	1.29		32.8	.82		20.9	.52		13.1
AEN4C12022B	11.66		296.4	1.47		37.3	1.29		32.8	.82		20.9	.52		13.1

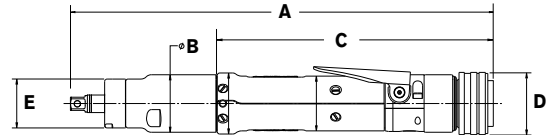

DIMENSIONS

INLINE	IN	(A)	MM	IN	(B)	MM	IN	(C)	MM	IN	(D)	MM	IN	(E)	MM
AES4A12003B	11.12		282.7	1.47		37.3	7.38		187.5	1.59		40.4	1.25		31.8
AES4A12006B	11.12		282.7	1.47		37.3	7.38		187.5	1.59		40.4	1.25		31.8
AES4A12011B	11.44		290.5	1.47		37.3	7.38		187.5	1.59		40.4	1.25		31.8
AES4A12014B	11.44		290.5	1.56		39.6	7.38		187.5	1.59		40.4	1.25		31.8
AES4A12018B	11.44		290.5	1.47		37.3	7.38		187.5	1.59		40.4	1.25		31.8
AES4A12022B	11.44		290.5	1.47		37.3	7.38		187.5	1.59		40.4	1.25		31.8
PUSH-TO-START	IN	(A)	MM	IN	(B)	MM	IN	(C)	MM	IN	(D)	MM	IN	(E)	MM
AEL4A12003B	11.31		287.3	1.56		39.6	7.38		187.5	1.59		40.4	1.25		31.8
AEL4A12006B	11.32		287.4	1.56		39.6	7.38		187.5	1.59		40.4	1.25		31.8
AEL4A12011B	11.62		295.4	1.56		39.6	7.38		187.5	1.59		40.4	1.25		31.8
AEL4A12014B	11.62		295.4	1.56		39.6	7.38		187.5	1.59		40.4	1.25		31.8
AEL4A12018B	11.62		295.4	1.56		39.6	7.38		187.5	1.59		40.4	1.25		31.8
AEL4A12022B	11.62		295.4	1.56		39.6	7.38		187.5	1.59		40.4	1.25		31.8

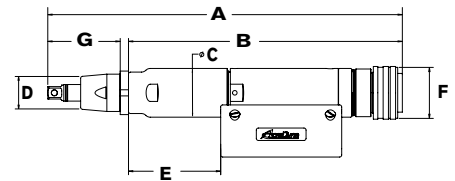

DIMENSIONS

FIXTURED	IN	(A)	MM	IN	(B)	MM	IN	(C)	MM	IN	(D)	MM	IN	(E)	MM	IN	(F)	MM	IN	(G)	MM
AEF4A12003B	11.53		292.9	9.10		231.04	1.47		37.3	1.13		28.57	2.06		52.2	1.59		40.4	2.18		55.5
AEF4A12006B	11.53		292.9	9.10		231.04	1.47		37.3	1.13		28.57	2.06		52.2	1.59		40.4	2.18		55.5
AEF4A12011B	12.20		309.8	9.10		231.04	1.47		37.3	1.13		28.57	2.72		69.1	1.59		40.4	2.18		55.5
AEF4A12014B	12.20		309.8	9.10		231.04	1.47		37.3	1.13		28.57	2.72		69.1	1.59		40.4	2.18		55.5
AEF4A12018B	12.20		309.8	9.10		231.04	1.47		37.3	1.13		28.57	2.72		69.1	1.59		40.4	2.18		55.5
AEF4A12022B	12.20		309.8	9.10		231.04	1.47		37.3	1.13		28.57	2.72		69.1	1.59		40.4	2.18		55.5
AEF4C12003B	15.32		389.2	9.10		231.04	1.47		37.3	1.13		28.57	2.06		52.2	1.59		40.4	5.98		151.8
AEF4C12006B	15.32		389.2	9.10		231.04	1.47		37.3	1.13		28.57	2.06		52.2	1.59		40.4	5.98		151.8
AEF4C12011B	15.99		406.1	9.10		231.04	1.47		37.3	1.13		28.57	2.72		69.1	1.59		40.4	5.98		151.8
AEF4C12014B	15.99		406.1	9.10		231.04	1.47		37.3	1.13		28.57	2.72		69.1	1.59		40.4	5.98		151.8
AEF4C12018B	15.99		406.1	9.10		231.04	1.47		37.3	1.13		28.57	2.72		69.1	1.59		40.4	5.98		151.8
AEF4C12022B	15.99		406.1	9.10		231.04	1.47		37.3	1.13		28.57	2.72		69.1	1.59		40.4	5.98		151.8
AEF4X12003B	9.35		237.5	9.10		231.04	1.47		37.3	1.13		28.57	2.06		52.2	1.59		40.4	.80		20.4
AEF4X12006B	9.35		237.5	9.10		231.04	1.47		37.3	1.13		28.57	2.06		52.2	1.59		40.4	.80		20.4
AEF4X12011B	10.00		254.4	9.10		231.04	1.47		37.3	1.13		28.57	2.72		69.1	1.59		40.4	.80		20.4
AEF4X12014B	10.00		254.4	9.10		231.04	1.47		37.3	1.13		28.57	2.72		69.1	1.59		40.4	.80		20.4
AEF4X12018B	10.00		254.4	9.10		231.04	1.47		37.3	1.13		28.57	2.72		69.1	1.59		40.4	.80		20.4
AEF4X12022B	10.00		254.4	9.10		231.04	1.47		37.3	1.13		28.57	2.72		69.1	1.59		40.4	.80		20.4

ACRADYNE PISTOL GRIP NUTRUNNERS

FEATURES AND BENEFITS

- 1000 & 2000 series tools available with bottom exit, rear exit, or top exit cable configurations. 5000 series tools available in bottom exit or top exit models
- AcraDyne's multi-function button (MFB) provides increased flexibility
- On-board lights and audible signal for operator feedback
- Push-To-Start models also available

1000 & 2000 Series



5000 Series



APPLICATION DATA

	MAX TORQUE		TORQUE RANGE		FREE SPEED	WEIGHT (-) SOCKET		OUTPUT	(A)		(B)		(C)		(D)	
	NM	FT-LB	NM	FT-LB		RPM	LB		KG	SQ	DR	IN	MM	IN	MM	IN
1000 SERIES*																
AEP4(A)(R)(T)12003B(V)(Q)	3	2.2	0.8 - 3	0.6 - 2.2	2,625	2.2	1.00	3/8*	7.34	178.8	0.54	13.7	6.01	152.6	1.96	49.7
AEP4(A)(R)(T)12006B(V)(Q)	6	4.4	1.5 - 6	1.1 - 4.4	2,625	2.2	1.00	3/8*	7.34	178.8	0.54	13.7	6.01	152.6	1.96	49.7
AEP4(A)(R)(T)12011B(V)(Q)	11	8.1	2.8 - 11	2 - 8.1	1,313	2.3	1.04	3/8	8.00	203.3	0.54	13.7	6.01	152.6	1.96	49.7
AEP4(A)(R)(T)12014B(V)(Q)	14	10	3.5 - 14	2.6 - 10	1,037	2.3	1.04	3/8	8.00	203.3	0.54	13.7	6.01	152.6	1.96	49.7
AEP4(A)(R)(T)12018BV	18	13	4.5 - 18	3.3 - 13	840	2.3	1.04	3/8	8.00	203.3	0.54	13.7	6.01	152.6	1.96	49.7
AEP4(A)(R)(T)12022BV	22	16	5.5 - 22	4.1 - 16	656	2.3	1.04	3/8	8.00	203.3	0.54	13.7	6.01	152.6	1.96	49.7
2000 SERIES*																
AEP4(A)(R)(T)22020BV	20	14	5 - 20	3.7 - 14	1,313	2.4	1.09	3/8	8.66	219.9	0.56	14.2	6.87	174.4	1.96	49.7
AEP4(A)(R)(T)22025BV	25	18	6.3 - 25	4.6 - 18	1,037	2.4	1.09	3/8	8.66	219.9	0.56	14.2	6.87	174.4	1.96	49.7
AEP4(A)(R)(T)22030BV	30	22	7.5 - 30	5.5 - 22	840	2.4	1.09	3/8	8.66	219.9	0.56	14.2	6.87	174.4	1.96	49.7
AEP4(A)(R)(T)22035BV	35	25	8.8 - 35	6.5 - 25	747	2.4	1.09	3/8	8.66	219.9	0.56	14.2	6.87	174.4	1.96	49.7
AEP4(A)(R)(T)22040BV	40	29	10 - 40	7.4 - 29	656	2.4	1.09	3/8	8.66	219.9	0.56	14.2	6.87	174.4	1.96	49.7

* "V" indicates extended Ergo-Drive output. **E** Replace "V" with "Q" for 1/4" quick change output only as noted in the table.
 Add "A" to part numbers for bottom exit cable models. Add "R" to part numbers for rear exit cable models. Add "T" to part numbers for top exit cable models

	MAX TORQUE		TORQUE RANGE		FREE SPEED	WEIGHT (-) SOCKET		OUTPUT	(A)		(B)		(C)		(D)	
	NM	FT-LB	NM	FT-LB		RPM	LB		KG	SQ	DR	IN	MM	IN	MM	IN
5000 SERIES																
AEP35075AV(T)	75	55	19 - 75	14 - 55	944	9.2	4.17	1/2	15.95	405.2	.68	17.4	7.37	187.1	1.96	49.7
AEP35090AV(T)	90	66	23 - 90	17 - 66	767	9.2	4.17	1/2	15.95	405.2	.68	17.4	7.37	187.1	1.96	49.7
AEP35110AV(T)	110	81	28 - 110	21 - 81	634	9.2	4.17	1/2	15.95	405.2	.68	17.4	7.37	187.1	1.96	49.7
AEP35135AV(T)	135	99	34 - 135	25 - 99	515	9.2	4.17	1/2	15.95	405.2	.68	17.4	7.37	187.1	1.96	49.7
AEP35170AV(T)	170	125	43 - 170	32 - 125	418	9.2	4.17	1/2	15.95	405.2	.68	17.4	7.37	187.1	1.96	49.7
AEP35280A(T)	280	206	70 - 280	52 - 207	236	13.6	6.17	3/4	18.43	468.2	1.11	28.1	7.37	187.1	1.96	49.7
AEP35350A(T)	350	258	88 - 350	65 - 258	192	13.6	6.17	3/4	18.43	468.2	1.11	28.1	7.37	187.1	1.96	49.7
AEP35420A(T)	420	310	105 - 420	78 - 310	159	13.6	6.17	3/4	18.43	468.2	1.11	28.1	7.37	187.1	1.96	49.7
AEP35515A(T)	515	380	128 - 515	95 - 380	129	13.6	6.17	3/4	18.43	468.2	1.11	28.1	7.37	187.1	1.96	49.7
AEP35635A(T)	635	468	159 - 635	117 - 469	104	13.6	6.17	3/4	18.43	468.2	1.11	28.1	7.37	187.1	1.96	49.7

"V" indicates extended Ergo-Drive output. **E**
 Add "T" to part numbers for top exit cable models

1000 Series
2000 Series

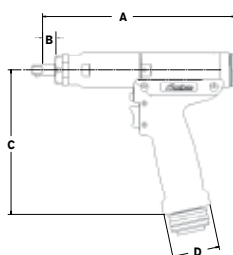

5000 Series

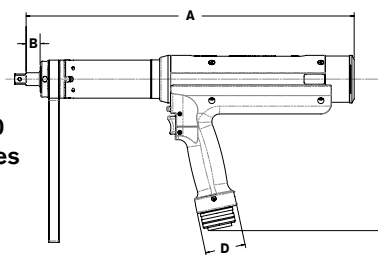

* **E** logo indicates where ERGO-DRIVE sockets/extensions benefit tool operation.

ACRADYNE ANGLE NUTRUNNERS

FEATURES AND BENEFITS

AcraDyne angle nutrunners provide the perfect solution to space-limited fastening applications. A compact, durable head houses a precision right-angle gear set which fits into the tightest spaces and delivers a highly accurate fastening cycle. Lightweight materials and a uniform body diameter provide a comfortable grip. The ergonomically placed start lever ensures simple control.



AEN32015C



AEN32025CDL



AEN33060C



AEN33200CF



AEN35140B



AEN35285B

APPLICATION DATA

	MAX TORQUE		TORQUE RANGE		FREE SPEED	WEIGHT (-) SOCKET		OUTPUT SO. DR	(A)		(B)		(C)		(D)		(E)	
	NM	FT-LB	NM	FT-LB		RPM	LB		KG	IN	MM	IN	MM	IN	MM	IN	MM	IN
2000 SERIES																		
AEN32015C(DL)	15	11	3 - 15	2.2 - 11	1,481	2.7	1.22	3/8	14.61	371	1.85	47	1.37	34.8	.90	22.9	.52	13.1
AEN32025C(DL)	25	18	5 - 20	3.7 - 15	833	2.7	1.22	3/8	14.61	371	1.85	47	1.37	34.8	.90	22.9	.52	13.1
AEN32030C(F)(DL)	30	22	6 - 30	4.4 - 22	803	2.8	1.27	3/8	14.42	366.2	1.85	47	1.65	41.8	1.16	29.4	.70	17.8
AEN32040C(F)(DL)	40	30	8 - 40	5.9 - 29	574	2.8	1.27	3/8	14.42	366.2	1.85	47	1.65	41.8	1.16	29.4	.70	17.8
3000 SERIES																		
AEN33042C(F)	42	31	9.5 - 42	7 - 31	1,095	4.4	2.00	3/8	16.63	422.33	1.85	47	1.66	42.11	1.17	29.67	.7	17.78
AEN33053C(F)	53	39	12 - 53	8 - 39	865	4.4	2.00	3/8	16.63	422.33	1.85	47	1.66	42.11	1.17	29.67	.7	17.78
AEN33060C(F)(DL)	60	44	12 - 60	9 - 44	845	6.6	2.99	1/2	18.92	480.53	1.85	47	1.90	48.36	1.37	34.90	.83	20.96
AEN33090C(F)(DL)	90	66	18 - 90	13 - 66	568	6.6	2.99	1/2	18.92	480.53	1.85	47	1.90	48.36	1.37	34.90	.83	20.96
AEN33120C(F)(DL)	120	89	24 - 120	18 - 88	442	9.3	4.22	1/2	21.00	533.46	1.85	47	2.78	70.59	2.08	52.81	1.05	26.67
AEN33200C(F)(DL)	200	148	40 - 200	29 - 147	245	9.4	4.26	3/4	23.21	589.64	1.85	47	2.59	65.75	1.89	47.98	1.05	26.67
AEN33210C(F)(DL)	210	95	50 - 210	37 - 155	234	10.0	4.54	3/4	23.58	598.88	1.85	47	2.90	73.53	1.97	50.04	1.25	31.75
AEN33300C(F)(DL)	300	221	60 - 300	42 - 221	151	10.0	4.54	3/4	23.58	598.88	1.85	47	2.90	73.53	1.97	50.04	1.25	31.75
AEN33375C(F)(DL)	375	277	75 - 375	55 - 276	151	10.0	4.54	3/4	23.58	598.88	1.85	47	2.90	73.53	1.97	50.04	1.25	31.75
5000 SERIES																		
AEN35090B(F)	90	66	23 - 90	17 - 66	607	6.9	3.13	1/2	22.59	573.7	2.31	58.7	1.90	48.4	1.37	34.9	.81	20.6
AEN35140B(F)	140	103	35 - 140	26 - 103	472	10.4	4.72	3/4	22.52	571.9	2.31	58.7	2.59	65.8	1.89	48	1.05	26.7
AEN35175B(F)	175	129	44 - 175	33 - 129	384	10.5	4.76	3/4	22.52	571.9	2.31	58.7	2.59	65.8	1.89	48	1.05	26.7
AEN35225B(F)	225	166	56 - 225	41 - 166	291	12.3	5.58	3/4	22.88	581.1	2.31	58.7	2.90	73.5	1.97	50	1.25	31.8
AEN35285B(F)	285	210	71 - 285	52 - 210	236	12.3	5.58	3/4	22.88	581.1	2.31	58.7	2.90	73.5	1.97	50	1.25	31.8
AEN35350B(F)	350	258	88 - 350	65 - 258	191	12.3	5.58	3/4	22.88	581.1	2.31	58.7	2.90	73.5	1.97	50	1.25	31.8

* Add "F" to part numbers for flush socket only as noted in the table.
Add "DL" to part numbers for dual levers only as noted in the table.

2000 & 3000 Series

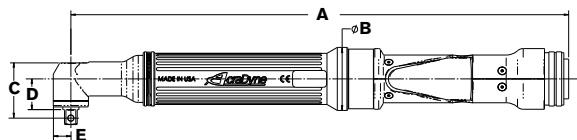

5000 Series

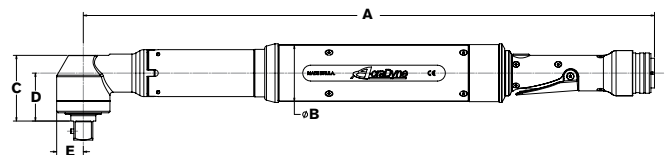

ACRADYNE INLINE NUTRUNNERS

FEATURES AND BENEFITS

Due to their compact size and durability, AcraDyne inline nutrunners are the ideal choice for fixtured fastening applications. A uniform body diameter and a hex shaped mounting point allow for simple installation into fixtured plates. A reaction bar for use in handheld applications is also included with all AcraDyne inline nutrunners.



APPLICATION DATA

	MAX TORQUE		TORQUE RANGE		FREE SPEED RPM	WEIGHT (-) SOCKET		OUTPUT SQ. DR IN	(A)		(B)		(C)		(D)		(E)	
	NM	FT-LB	NM	FT-LB		LB	KG		IN	MM	IN	MM	IN	MM	IN	MM	IN	MM
2000 SERIES*																		
AES32010C(V)(Q)	10	7.4	2 - 10	1.5 - 7.4	2,222	2.5	1.13	3/8"	13.85	351.7	1.59	40.4	1.85	47	.56	14.3	1.59	40.4
AES32020C(V)(Q)	20	15	4 - 20	3.0 - 15	1,250	2.5	1.13	3/8"	13.85	351.7	1.59	40.4	1.85	47	.56	14.3	1.59	40.4
AES32025C(V)(Q)	25	18	5 - 25	3.7 - 18	893	3.2	1.45	3/8"	13.85	351.7	1.59	40.4	1.85	47	.56	14.3	1.59	40.4
AES32038C(V)	38	28	7.5 - 38	5.5 - 28	595	4.2	1.91	3/8"	16.69	424	1.50	38.1	1.85	47	.51	12.9	1.59	40.4
3000 SERIES*																		
AES33040C(V)(-2)	40	30	8 - 40	5.9 - 30	1,314	6.4	2.90	1/2"	18.24	463.38	1.94	49.28	1.85	47	.68	17.17	1.59	40.4
AES33060C(V)(-2)	60	44	12 - 60	8.9 - 44	883	6.4	2.90	1/2"	18.24	463.38	1.94	49.28	1.85	47	.68	17.17	1.59	40.4
AES33100C(V)(-2)	100	74	20 - 100	15 - 74	489	8.1	3.67	1/2"	22.56	572.99	1.94	49.28	1.85	47	.68	17.17	1.59	40.4
AES33150CV	150	111	30 - 150	22 - 111	329	8.1	3.67	1/2"	22.56	572.99	1.94	49.28	1.85	47	.68	17.17	1.59	40.4
AES33150C-2	150	111	30 - 150	22 - 111	329	8.1	3.67	3/4"	22.56	572.99	1.94	49.28	1.85	47	.68	17.17	1.59	40.4
AES33230CV	185	137	46 - 185	34 - 137	221	8.1	3.67	1/2"	22.56	572.99	1.94	49.28	1.85	47	.68	17.17	1.59	40.4
AES33230C-2	230	170	46 - 230	34 - 170	221	8.1	3.67	3/4"	22.56	572.99	1.94	49.28	1.85	47	.68	17.17	1.59	40.4
AES33400C	400	295	80 - 400	59 - 295	122	13.0**	5.90**	3/4"	24.90	632.46	1.94	49.28	1.85	47	1.11	28.08	1.59	40.4
AES33600C	600	443	120 - 600	89 - 443	82	13.0**	5.90**	3/4"	24.90	632.46	1.94	49.28	1.85	47	1.11	28.08	1.59	40.4
5000 SERIES																		
AES35075AV	75	55	19 - 75	14 - 55	944	9.2	4.17	1/2"	21.86	555.2	1.85	47	2.31	58.7	.68	17.4	1.59	40.4
AES35090AV	90	66	23 - 90	17 - 66	767	9.2	4.17	1/2"	21.86	555.2	1.85	47	2.31	58.7	.68	17.4	1.59	40.4
AES35110AV	110	81	28 - 110	21 - 81	634	9.2	4.17	1/2"	21.86	555.2	1.85	47	2.31	58.7	.68	17.4	1.59	40.4
AES35135AV	135	100	34 - 135	25 - 100	515	9.2	4.17	1/2"	21.86	555.2	1.85	47	2.31	58.7	.68	17.4	1.59	40.4
AES35170AV	170	126	43 - 170	32 - 126	418	9.2	4.17	1/2"	21.86	555.2	1.85	47	2.31	58.7	.68	17.4	1.59	40.4
AES35280A	280	207	70 - 280	52 - 207	236	12.8	5.81	3/4"	24.34	618.2	1.85	47	2.31	58.7	1.19	30.1	1.59	40.4
AES35350A	350	258	88 - 350	65 - 258	192	12.8	5.81	3/4"	24.34	618.2	1.85	47	2.31	58.7	1.19	30.1	1.59	40.4
AES35420A	420	310	105 - 420	78 - 310	159	12.8	5.81	3/4"	24.34	618.2	1.85	47	2.31	58.7	1.19	30.1	1.59	40.4
AES35515A	515	380	128 - 515	95 - 380	129	12.8	5.81	3/4"	24.34	618.2	1.85	47	2.31	58.7	1.19	30.1	1.59	40.4
AES35635A	635	469	159 - 635	117 - 469	104	12.8	5.81	3/4"	24.34	618.2	1.85	47	2.31	58.7	1.19	30.1	1.59	40.4

* 2000 series tools are available in "V" for Ergo-Drive and Q for 1/4" quick-change models only as noted in the table.
 3000 series tools are available in "V" for Ergo-Drive and "-2" models for 2" sliding spindle only as noted in the table.
 5000 series tools: "V" indicates extended Ergo-Drive output.
 ** Includes reaction bar and fixture nut

2000 & 3000 Series

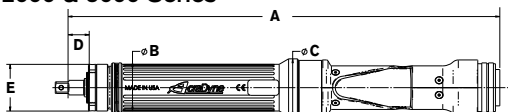

5000 Series

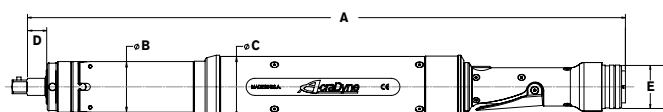

* **E** logo indicates where ERGO-DRIVE sockets/extensions benefit tool operation.

ACRADYNE FIXTURED NUTRUNNERS



AEF35135AV
Standard Spindle, Rear Exit Cable



AEF35135AVB
Standard Spindle, Bottom Exit Cable



AEF35350A
Standard Spindle, Rear Exit Cable



AEF35135A-2
2" Sliding Spindle, Rear Exit Cable



AEF35135AB-2
2" Sliding Spindle, Bottom Exit Cable

APPLICATION DATA

5000 SERIES*	NM	MAX TORQUE FT-LB	NM	TORQUE RANGE FT-LB	FREE SPEED RPM	LB	WEIGHT (-) SOCKET KG	OUTPUT DRIVE
AEF35075A(V)(VB)(-2)(B-2)	75	55	19 - 75	14 - 55	944	9.6	4.35	1/2 SQ. DR.
AEF35090A(V)(VB)(-2)(B-2)	90	66	23 - 90	17 - 66	767	9.6	4.35	1/2 SQ. DR.
AEF35110A(V)(VB)(-2)(B-2)	110	81	28 - 110	21 - 81	634	9.6	4.35	1/2 SQ. DR.
AEF35135A(V)(VB)(-2)(B-2)	135	100	34 - 135	25 - 100	515	9.6	4.35	1/2 SQ. DR.
AEF35170A(V)(VB)	170	125	43 - 170	32 - 125	418	9.6	4.35	1/2 SQ. DR.
AEF35170A(-2)(B-2)	170	125	43 - 170	32 - 125	418	9.6	4.35	3/4 SQ. DR.
AEF35280A(B)**	280	207	70 - 280	52 - 207	236	13.6	6.17	3/4 SQ. DR.
AEF35350A(B)**	350	258	88 - 350	65 - 258	192	13.6	6.17	3/4 SQ. DR.
AEF35420A(B)**	420	310	105 - 420	77 - 310	159	13.6	6.17	3/4 SQ. DR.
AEF35515A(B)**	515	380	128 - 515	95 - 380	129	13.6	6.17	3/4 SQ. DR.
AEF35635A(B)**	635	469	159 - 635	117 - 469	104	13.6	6.17	3/4 SQ. DR.

* "V" = standard spindle with rear exit cable. "VB" = standard spindle with bottom exit cable. "B" = bottom exit cable

"-2" = 2" sliding spindle with rear exit cable. "B-2" = 2" sliding spindle with bottom exit cable.

** Item 28843 is a panel mount 2" sliding spindle for 280 - 635 Nm models.

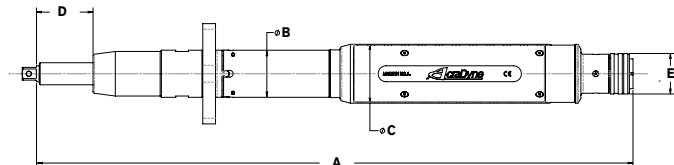

DIMENSIONS

5000 SERIES	IN	(A) MM	IN	(B) MM	IN	(C) MM	IN	(D) MM	IN	(E) MM
AEF35075AV	18	457.2	1.85	47	2.31	58.7	.72	18.4	1.59	40.4
AEF35090AV	18	457.2	1.85	47	2.31	58.7	.72	18.4	1.59	40.4
AEF35110AV	18	457.2	1.85	47	2.31	58.7	.72	18.4	1.59	40.4
AEF35135AV	18	457.2	1.85	47	2.31	58.7	.72	18.4	1.59	40.4
AEF35170AV	18	457.2	1.85	47	2.31	58.7	.72	18.4	1.59	40.4
AEF35075A-2	23.48	596.3	1.85	47	2.31	58.7	2.23	56.6	1.59	40.4
AEF35090A-2	23.48	596.3	1.85	47	2.31	58.7	2.23	56.6	1.59	40.4
AEF35110A-2	23.48	596.3	1.85	47	2.31	58.7	2.23	56.6	1.59	40.4
AEF35135A-2	23.48	596.3	1.85	47	2.31	58.7	2.23	56.6	1.59	40.4
AEF35170A-2	23.48	596.3	1.85	47	2.31	58.7	2.23	56.6	1.59	40.4
AEF35280A	20.4	518.1	1.85	47	2.31	58.7	1.86	47.1	1.59	40.4
AEF35350A	20.4	518.1	1.85	47	2.31	58.7	1.86	47.1	1.59	40.4
AEF35420A	20.4	518.1	1.85	47	2.31	58.7	1.86	47.1	1.59	40.4
AEF35515A	20.4	518.1	1.85	47	2.31	58.7	1.86	47.1	1.59	40.4
AEF35635A	20.4	518.1	1.85	47	2.31	58.7	1.86	47.1	1.59	40.4

* logo indicates where ERGO-DRIVE sockets/extensions benefit tool operation.

ACRADYNE TUBENUT NUTRUNNERS AND SPECIALTY GEARHEADS

FEATURES AND BENEFITS

- Patented safety algorithm
- Transducer senses resistance in the initial 90 degrees of rotation and returns to open upon any resistance encountered
- Durable tubenut head design
- Simple, one-touch back to open operation for maximum productivity



AET 2000 Series Model



AET 1000 Series Model



AET 2000 Series Model with Double Levers

WITH INNOVATIVE SAFETY SENSOR TECHNOLOGY!

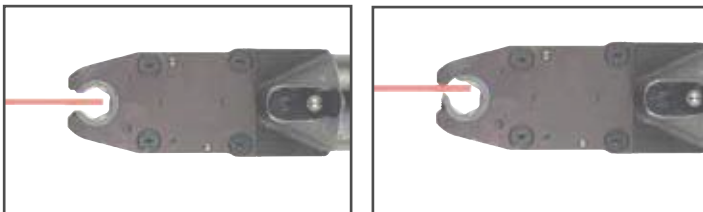

APPLICATION DATA

1000 SERIES*	NM	MAX TORQUE FT-LB	NM	TORQUE RANGE FT-LB	FREE SPEED RPM	LB	WEIGHT (-) SOCKET KG	IN	OUTPUT DRIVE NM
AET4AA12018B	14	13	3.6 - 14	2.7 - 11	516	3.1	1.41	1/4 - 7/16	7 - 12
AET4AB12025B	20	18	5 - 20	3.7 - 15	387	3.1	1.41	3/8 - 5/8	10 - 17
AET4A12025B-KD	25	18	5 - 25	3.7 - 18	387	3.1	1.41	3/8 - 5/8	10 - 17

2000 SERIES*	NM	MAX TORQUE FT-LB	NM	TORQUE RANGE FT-LB	FREE SPEED RPM	LB	WEIGHT (-) SOCKET KG	IN	OUTPUT DRIVE NM
AET32020C(DL)	20	15	4 - 16	3.0 - 12	622	3.1	1.41	1/4 - 7/16	7 - 12
AET32025C(DL)	25	18	5 - 20	3.7 - 15	466	4.0	1.81	3/8 - 5/8	10 - 17
AET32035C(DL)	35	26	7 - 28	5.2 - 21	347	4.5	2.04	1/2 - 7/8	13 - 24
AET32050C(DL)	50	37	10 - 40	7.4 - 30	257	5.6	2.54	5/8 - 1-3/16	17 - 32

* Add "DL" to part numbers for double levers. Request specific socket size when placing your order. AIMCO offers a wide variety of socket sizes to fit your needs. Contact AIMCO at 1-503-254-6600, or toll free 1-800-852-1368.

SPECIALTY GEARHEADS

AIMCO can provide specialized heads for most any application. Tubenut, Hold and Drive, Crow Foot, Offsets, and Sliding Spindles are just a few of the head styles available. Whatever the requirements, AIMCO will recommend the head configuration that will get the job done successfully.



ACRADYNE HOLD & DRIVE NUTRUNNERS

FEATURES AND BENEFITS

- Torques ranging from 20 Nm – 200 Nm
- Very robust design
- 1" and 2" travels are standard
- Sockets and holders are custom

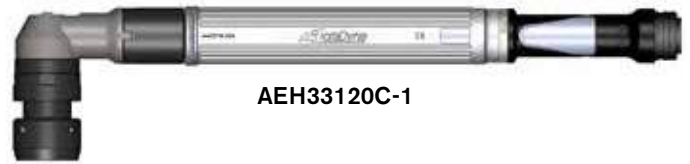

AEH33120C-1



AEH32040C-1

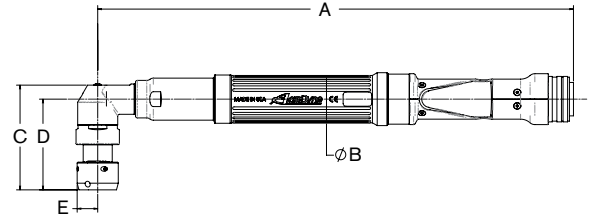

APPLICATION DATA

MODEL*	MAX TORQUE		TORQUE RANGE		FREE SPEED RPM	WEIGHT (LB)	MIN SOCKET MAX SOCKET	(A)		(B)		(C)		(D)		(E)	
	NM	FT-LB	NM	FT-LB				IN	MM	IN	MM	IN	MM	IN	MM	IN	MM
AEH4F12020B-(1,2)	20	15	4 - 20	3 - 15	533	-1 = 2.8 -2 = 3.0	9/16 (14 MM) 13/16, (21 MM)	14.59	370.7	1.59	40.4	3.72	94.4	3.17	80.6	.76	19.3
AEH4F12026B-(1,2)	26	19	5 - 26	4 - 19	432	-1 = 2.8 -2 = 3.1	9/16 (14 MM) 3/16, (21 MM)	14.59	370.7	1.59	40.4	3.72	94.4	3.17	80.6	.76	9.3
AEH32025C-(1,2)	25	18	5 - 25	4 - 18	833	-1 = 3.5 -2 = 3.5	9/16 (14 MM) 13/16, (21 MM)	14.59	370.7	1.85	47	3.72	94.4	3.17	80.6	.76	19.3
AEH32030C-(1,2)	30	22	6 - 30	4 - 22	803	-1 = 3.5 -2 = 3.6	9/16 (14 MM) 13/16, (21 MM)	14.59	370.7	1.85	47	3.72	94.4	3.17	80.6	.76	19.3
AEH32040C-(1,2)	40	30	8 - 40	6 - 30	574	-1 = 3.5 -2 = 3.7	9/16 (14 MM) 13/16, (21 MM)	14.59	370.7	1.85	47	3.72	94.4	3.17	80.6	.76	19.3
AEH33042C-(1,2)	42	31	10 - 42	7 - 31	1,095	-1 = 5.6 -2 = 5.8	9/16 (14 MM) 13/16, (21 MM)	16.79	426.5	1.85	47	3.72	94.4	3.17	80.6	.76	19.3
AEH33053C-(1,2)	53	39.	12 - 53	8 - 39	865	-1 = 5.6 -2 = 5.8	9/16 (14 MM) 13/16, (21 MM)	16.79	426.5	1.85	47	3.72	94.4	3.17	80.6	.76	19.3
AEH33060C-(1,2)	60	44	12 - 60	9 - 44	845	-1 = 7.3 -2 = 7.5	9/16 (14 MM) 1-1/4, (32 MM)	18.92	480.5	1.96	49.8	4.04	102.5	3.37	85.66	.94	23.9
AEH33090C-(1,2)	90	66	18 - 90	13 - 66	568	-1 = 7.3 -2 = 7.6	9/16 (14 MM) 1-1/4, (32 MM)	18.92	480.5	1.96	49.8	4.04	102.5	3.37	85.66	.94	23.9
AEH33120C-(1,2)	120	89	24 - 120	18 - 89	442	-1 = 10.0 -2 = 10.3	5/8 (15 MM) 1-1/4, (32 MM)	21.00	533.5	1.96	49.8	4.87	123.7	4.09	103.82	1.13	28.6
AEH33200C-(1,2)	200	148	40 - 200	29 - 148	245	-1 = 10.0 -2 = 10.4	5/8 (16 MM) 1-1/4, (32 MM)	23.21	589.5	1.96	49.8	4.87	123.7	4.09	103.82	1.13	28.6
AEH35090B-(1,2)	90	66	23 - 90	17 - 66	607	-1 = 7.6 -2 = 7.9	9/16 (14 MM) 1-1/4, (32 MM)	22.63	574.8	2.31	58.7	4.02	102.1	3.36	85.26	1.32	33.4
AEH35140B-(1,2)	140	103	35 - 140	26 - 103	472	-1 = 10.6 -2 = 11.0	5/8 (15 MM) 1-1/4, (32 MM)	22.52	571.9	2.31	58.7	4.87	123.7	4.09	103.82	1.13	28.6
AEH35175B-(1,2)	175	129	44 - 175	33 - 129	384	-1 = 10.6 -2 = 11.1	5/8 (15 MM) 1-1/4, (32 MM)	22.52	571.9	2.31	58.7	4.87	123.7	4.09	103.82	1.13	28.6
AEH35225B-(1,2)	225	166	56 - 225	41 - 166	291	-1 = 12.9 -2 = 13.3	3/4 (19MM) 1-1/4, (32 MM)	22.92	582.2	2.31	58.7	5.52	140.1	5.52	112.2	1.32	33.4
AEH35285B-(1,2)	285	210	71 - 285	52 - 210	236	-1 = 12.9 -2 = 13.3	3/4 (19MM) 1-1/4, (32 MM)	22.92	582.2	2.31	58.7	5.52	140.1	5.52	112.2	1.32	33.4
AEH35350B-(1,2)	350	258	88 - 350	65 - 258	191	-1 = 12.9 -2 = 13.3	3/4 (19MM) 1-1/4, (32 MM)	22.92	582.2	2.31	58.7	5.52	140.1	5.52	112.2	1.32	33.4

* Add "1" to part numbers for 1" travel. Add "2" to part numbers for 2" travel.

ACRADYNE MID-EXIT CABLE NUTRUNNERS

FEATURES AND BENEFITS

- Length
 - Reduced tool length due to cable exiting in front of grip surface
- Ergonomics
 - Reduced torque reaction compared to pistol-style tools
 - The inline handle, coupled with the ergonomic hand positioning, allows for increased leverage and decreased strain on the wrist
- Cable management
 - If used with a spring balancer, the tool hangs naturally near its center of gravity, the cable is controlled by the balancer
 - Front positioning of cable provides for easy cable management

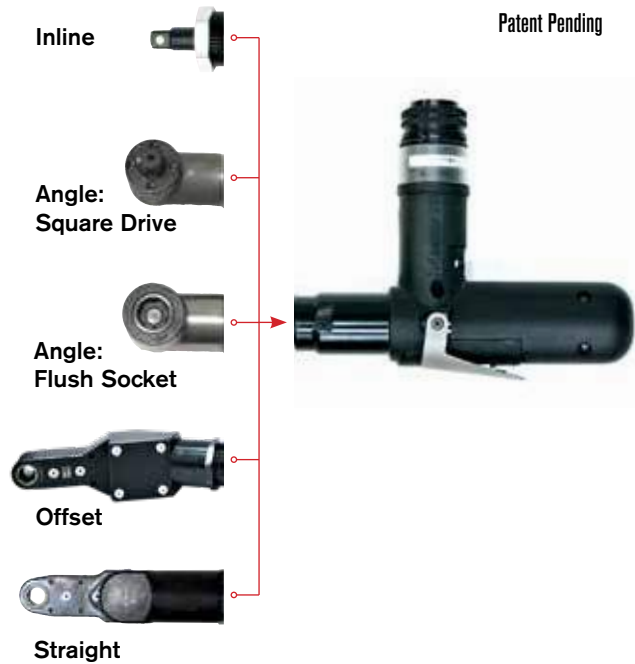

Specialized heads and blades available by request.
Contact AIMCO at 1-503-254-6600, or toll free 1-800-852-1368.

APPLICATION DATA

MODEL*	NM	MAX TORQUE	FT-LB	NM	TORQUE RANGE	FT-LB	FREE SPEED RPM	LB	WEIGHT (-) SOCKET	KG	OUTPUT DRIVE
AEN4C22015BM(F)	15		11	3.75 - 15		2.77 - 11	700	2.6		1.18	3/8 sq. dr.
AEN4F22030BM(F)	30		22	7.5 - 30		5.53 - 22	675	3.3		1.50	3/8 sq. dr.
AEN4F22037BM(F)	37		29	9.25 - 37		6.82 - 29	533	3.3		1.50	3/8 sq. dr.
AEN4F22044BM(F)	44		32	11 - 40		8.11 - 29	432	3.3		1.50	3/8 sq. dr.
AES4A22020BVM	20		15	5 - 20		3.7 - 15	1050	2.4		1.09	3/8 sq. dr.
AES4A22025BVM	25		18	6.3 - 25		4.6 - 18	830	2.4		1.09	3/8 sq. dr.
AES4A22030BVM	30		22	7.5 - 30		5.5 - 22	672	2.4		1.09	3/8 sq. dr.
AES4A22040BVM	40		30	10 - 40		7.4 - 30	525	2.4		1.09	3/8 sq. dr.

* Add "F" to part numbers for flush socket.

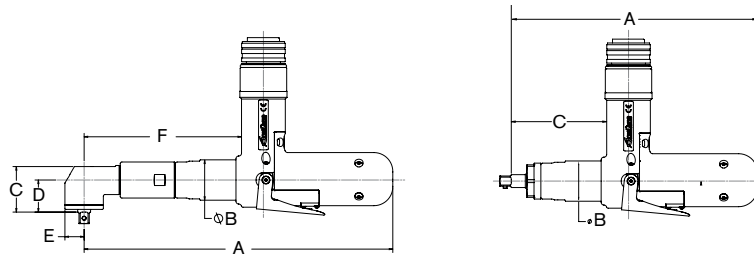

DIMENSIONS

MODEL	IN	(A)	MM	IN	(B)	MM	IN	(C)	MM	IN	(D)	MM	IN	(E)	MM	IN	(F)	MM
AEN4C22015BM	9.02		229.1	1.47		37.3	1.29		32.8	.82		20.9	.52		13.1	5.53		140.4
AEN4F22030BM	11.24		285.6	1.47		37.3	1.66		42.1	1.17		29.7	.70		17.8	5.73		145.6
AEN4F22037BM	11.24		285.6	1.47		37.3	1.66		42.1	1.17		29.7	.70		17.8	5.73		145.6
AEN4F22044BM	11.24		285.6	1.47		37.3	1.66		42.1	1.17		29.7	.70		17.8	5.73		145.6
AES4A22020BM	9.0		228.1	1.47		37.3	3.49		88.6	-		-	-		-	-		-
AES4A22025BM	9.0		228.1	1.47		37.3	3.49		88.6	-		-	-		-	-		-
AES4A22030BM	9.0		228.1	1.47		37.3	3.49		88.6	-		-	-		-	-		-
AES4A22040BM	9.0		228.1	1.47		37.3	3.49		88.6	-		-	-		-	-		-

ACRADYNE RIVET NUTRUNNERS

FEATURES AND BENEFITS

- Pull-to-torque tool/controller system ensures accurate, repeatable, and measurable tightening every time
- 1000 & 2000 series tools available with bottom exit, rear exit, or top exit cable configurations. Straight, Fixtured, and Push-to-Start models are available by request. Contact AIMCO at 1-503-254-6600, or toll free 1-800-852-1368
- Simple, quick mandrel change design
- Low-friction coating on mandrel for extended life
- Precise control of rivet compression with Torque and Angle detection capability
- Suitable for a wide range of material thicknesses – limited only by rivet nut size
- Data collection and networking capabilities to capture and utilize result data for QMS systems and line controls
- Multi-function button (MFB) provides increased flexibility
- On-board lights and audible signal for operator feedback
- Works with rivet sizes M4 – M10 or 8-32 – 3/8-16



APPLICATION DATA

MODEL*	MAX TORQUE		TORQUE RANGE		FREE SPEED RPM	WEIGHT (-) SOCKET		OUTPUT SQ DR	(A)		(B)		(C)		(D)*	
	NM	FT-LB	NM	FT-LB		LB	KG		IN	MM	IN	MM	IN	MM	IN	MM
1000 SERIES*																
AEP4(A)(R)(T)12006BR	6	4.4	1.5 - 6	1.1 - 4.4	2,625	2.2	1.00	3/8	9.68	245.9	1.05	26.7	6.01	152.6	1.96	49.8
AEP4(A)(R)(T)12011BR	11	8.1	2.8 - 11	2 - 8.1	1,313	2.3	1.04	3/8	9.68	245.9	1.05	26.7	6.87	174.5	1.96	49.8
AEP4(A)(R)(T)12014BR	14	10	3.5 - 14	2.6 - 10	1,037	2.3	1.04	3/8	9.68	245.9	1.05	26.7	6.87	174.5	1.96	49.8
AEP4(A)(R)(T)12018BR	18	13	4.5 - 18	3.3 - 13	840	2.3	1.04	3/8	9.68	245.9	1.05	26.7	6.87	174.5	1.96	49.8
AEP4(A)(R)(T)12022BR	22	16	5.5 - 22	4.1 - 16	656	2.3	1.04	3/8	9.68	245.9	1.05	26.7	6.87	174.5	1.96	49.8
AEP4(A)(R)(T)22020BR	20	15	5 - 20	3.7 - 15	1,313	2.4	1.09	3/8	10.18	258.6	1.05	26.7	6.87	174.5	1.96	49.8
AEP4(A)(R)(T)22030BR	30	22	7.5 - 30	5.5 - 22	840	2.4	1.09	3/8	10.18	258.6	1.05	26.7	6.87	174.5	1.96	49.8
AEP4(A)(R)(T)22040BR	40	30	10 - 40	7.4 - 30	656	2.4	1.09	3/8	10.18	258.6	1.05	26.7	6.87	174.5	1.96	49.8

* Add "A" to part numbers for bottom exit cable models, Add "R" to part numbers for rear exit cable models, Add "T" to part numbers for top exit cable models.

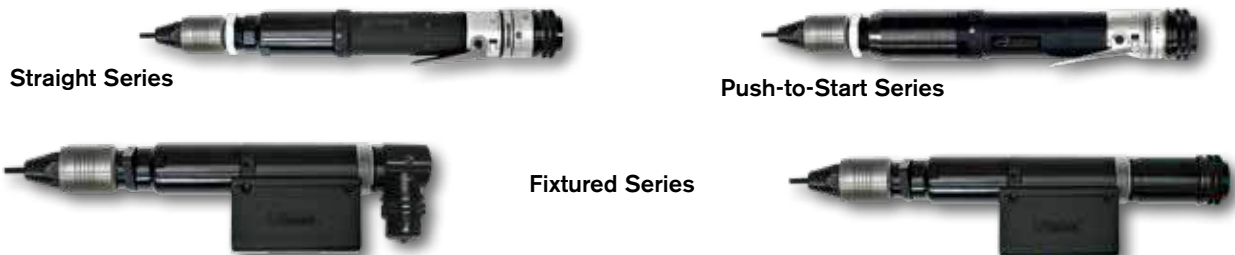

ACRADYNE HIGH TORQUE DC TOOLS

Critical bolting demands tools that deliver high torque with superior performance. Couple with AcraDyne's Controller, the HT Series tools combine these features in an electric, high-torque bolting system that beats the competition in accuracy, speed, and safety.

FEATURES AND BENEFITS

- One of the most accurate high-torque tools in the world today
- Up to 100 times faster than hydraulic tools
- 250 Nm – 12,000 Nm
- Ergonomic, robust design with five handle configurations
- Over 300 models to choose from
- Built-in integral transducer for optimal monitoring and control
- Traceable results at the square drive provide the most reliable and accurate data
- Data retrieval
- Designed and **MADE IN THE USA**



Straight Lever Type (AES)



Pistol Type (AEP)



Rear Mounted Pistol (AED)



Axial Type (AEJ)



Fixtured Type (AEF)

FIXED GEARCASE MODEL*	SERIES	APPROX. TORQUE		APPROX. SPEED RPM	WEIGHT		LENGTH		DIA.		DRIVE IN	SOUND LEVEL dB(A)
		NM	FT-LB		KG	LB	MM	IN	MM	IN		
(AEP) (AED) (AES) (AEJ) (AEF)4A66250B	6000	250	185	315	4.6	10.5	254	10	66	2.6	0.75	66
(AEP) (AED) (AES) (AEJ) (AEF)4A66425B	6000	425	315	165	4.6	10.5	254	10	66	2.6	0.75	66
(AEP) (AED) (AES) (AEJ) (AEF)4A66625B	6000	625	460	106	4.8	10.5	254	10	66	2.6	0.75	66
(AEP) (AED) (AES) (AEJ) (AEF)4A66925B	6000	925	682	72	4.8	10.5	254	10	66	2.6	0.75	66
(AEP) (AED) (AES) (AEJ) (AEF)4A771200B	7000	1,200	885	65	6.6	14.5	259	10.2	76	3.0	1	66
(AEP) (AED) (AES) (AEJ) (AEF)4A773000B	7000	3,000	2,213	25	7.5	16.5	294	11.6	76	3.0	1	66
(AEP) (AED) (AES) (AEJ) (AEF)4A884200B1	8000	4,200	3,100	12	11.1	24.5	340	13.4	86	3.6	1	66
(AEP) (AED) (AES) (AEJ) (AEF)4A884200B	8000	4,200	3,100	12	11.1	24.5	340	13.4	86	3.6	1.5	66
(AEP) (AED) (AES) (AEJ) (AEF)4A885000B	8000	5,000	3,700	9	11.1	24.5	340	13.4	86	3.6	1.5	66
(AEP) (AED) (AES) (AEJ) (AEF)4A896500B	8000/9000	6,500	4,800	7	15.7	34.5	378	14.9	101	4.0	1.5	66
(AEP) (AED) (AES) (AEJ) (AEF)4A898100B**	8000/9000	8,100	6,000	5	15.7	34.5	378	14.9	101	4.0	1.5	66
(AEP) (AEJ)4A8X12000B**	8000/9000	12,000	8,850	3.5	23.0	51.0	526	21	131	5.2	1.5	66

* Add "B" to the end of the model number for bottom exit cable (AEF fixtured models only).

** 8,100 Nm and 12,000 Nm models are not supported by the Gen III controller platform. The Gen IV controller platform is required.

360° SWIVEL GEARCASE MODEL	SERIES	APPROX. TORQUE		APPROX. SPEED RPM	WEIGHT		LENGTH		DIA.		DRIVE IN	SOUND LEVEL dB(A)
		NM	FT-LB		KG	LB	MM	IN	MM	IN		
(AEP) (AEJ)4B66250B	6000	250	185	315	5.3	12	305	12	66	2.6	0.75	66
(AEP) (AEJ)4B66425B	6000	425	315	165	5.3	12	305	12	66	2.6	0.75	66
(AEP) (AEJ) (AED)4B66625B	6000	625	460	106	5.5	12	305	12	66	2.6	0.75	66
(AEP) (AEJ)4B66925B	6000	925	682	72	5.5	12	305	12	66	2.6	0.75	66
(AEP) (AEJ)4B771200B	7000	1,200	885	65	7.3	16	310	12.2	76	3.0	1	66
(AEP) (AEJ)4B773000B	7000	3,000	2,213	25	8.2	18	345	13.6	76	3.0	1	66
(AEP) (AEJ)4B884200B1	8000	4,200	3,100	12	11.8	26	391	15.4	86	3.6	1	66
(AEP) (AEJ)4B884200B	8000	4,200	3,100	12	11.8	26	391	15.4	86	3.6	1.5	66
(AEP) (AEJ)4B885000B	8000	5,000	3,700	9	11.8	26	391	15.4	86	3.6	1.5	66
(AEP) (AEJ)4B896500B	8000/9000	6,500	4,800	7	16.4	36	429	16.9	101	4.0	1.5	66
(AEP) (AEJ)4B898100B**	8000/9000	8,100	6,000	5	16.4	36	429	16.9	101	4.0	1.5	66
(AEP) (AEJ)4B8X12000B**	8000/9000	12,000	8,850	3.5	24.0	52.5	564	22	131	5.2	1.5	66

** 8,100 Nm and 12,000 Nm models are not supported by the Gen III controller platform. The Gen IV controller platform is required.

ACRADYNE HIGH TORQUE DC ANGLE TOOLS

FEATURES AND BENEFITS

- Transducerized closed loop control at the output like all AcraDyne HT-Series tools
- These low-profile head, small-diameter, lever-operated tools, with the torque measured at the output, offer a unique solution
- The torque reported is the torque delivered
- One of the most accurate high-torque right-angle tools in the world
- Smallest tools of their kind on the market
- Same durable, high-cycle gearing as our other HT-series tools
- Models up to 12,000 Nm available upon request



AEN3571000A



AEN356540A



AEN3571600A



AEN3572600A

SPECIFICATIONS

MODEL	MAX. TORQUE*		TORQUE RANGE		FREE SPEED RPM	WEIGHT		OUTPUT DRIVE
	NM	FT-LB	NM	FT-LB		LB	KG	
AEN356540A	540	398	135 - 540	100 - 398	109	13.1	5.95	3/4" Square Drive
AEN3571000A	1,000	737	250 - 1,000	184 - 737	61	16.3	7.39	1" Square Drive
AEN3571600A	1,600	1,180	400 - 1,600	295 - 1,180	33	16.7	7.57	1" Square Drive
AEN3572600A	2,600	1,917	650 - 2,600	479 - 1,917	21	18.5	8.40	1" Square Drive

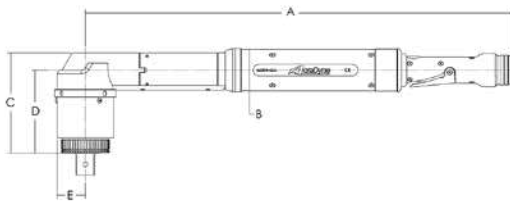

DIMENSIONS	A		B		C		D		E	
	IN	MM	IN	MM	IN	MM	IN	MM	IN	MM
AEN356540A	22.58	573.6	2.31	58.7	4.75	120.6	4.05	102.8	1.33	33.7
AEN3571000A	22.92	582.2	2.31	58.7	5.36	136.1	4.44	112.7	1.53	38.7
AEN3571600A	22.92	582.2	2.31	58.7	5.36	136.1	4.44	112.7	1.53	38.7
AEN3572600A	22.92	582.2	2.31	58.7	6.77	171.9	5.86	148.8	1.53	38.7

ACRADYNE HIGH TORQUE DUAL LEVER TOOLS

DUAL LEVER TOOLS

Provides Additional Safety by Avoiding Accidental Tool Start

FEATURES AND BENEFITS

- 250 Nm – 12,000 Nm
- Two-Hand No Tie Down Operation
 - No Tie Down Control: Operator must have both hands on and activating the dual-starting mechanisms simultaneously. Both hands must remain in position, activating the dual controls, at all times in order for the tool to operate.
- Additional safety when using a tool with a reaction bar or nose extension. Operator's hands remain on the controls and not in a position where they could be impacted by reaction devices
- Hands stay clear of application
- Helps avoid accidental starting of the tool
- Available in three handle types: "Handle Bar" (F) style, Straight (S) style with side handle, Pistol (P) style, and J-Handle (J) style

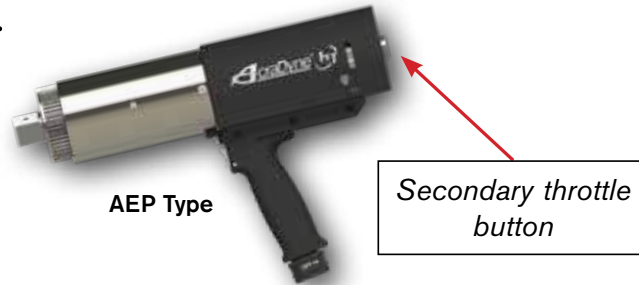

HT Dual-Lever Nutrunners: **SAFETY** is **VITAL** in Critical Bolting

AcraDyne's Nutrunners are designed with ultimate operator safety in mind. The optional dual-lever design helps prevent:



Injuries from Accidental Tool Start

Two-hand operation with no tie-down feature requires the operator to use both hands on the trigger simultaneously. This eliminates the possibility of accidental tool start and keeps both of the operator's hands out of harm's way.

Strain Caused by Awkward Tool Operation

Multiple handle styles ensure the safest, most ergonomic tool for your specific application.

Hand and Finger Trauma

Significantly reduce the risk of crushed or mutilated fingers from unintended tool start.

Protect your most valuable asset – your tool operator.

ACRADYNE HIGH TORQUE DUAL LEVER TOOLS



HT DUAL-LEVER NUTRUNNER SPECIFICATIONS

FIXED GEARCASE MODEL	SERIES	APPROX. TORQUE		APPROX. SPEED RPM	WEIGHT		LENGTH		DIA.		DRIVE IN	SOUND LEVEL dB(A)
		NM	FT-LB		KG	LB	MM	IN	MM	IN		
AE(S)(F)(P)4A66250BDL	6000	250	185	315	3.9	9	203	8	66	2.6	0.75	66
AE(S)(F)(P)4A66425BDL	6000	425	315	165	3.9	9	203	8	66	2.6	0.75	66
AE(S)(F)(P)4A66625BDL	6000	625	460	106	4.1	9	203	8	66	2.6	0.75	66
AE(S)(F)(P)4A66925BDL	6000	925	682	72	4.1	9	203	8	66	2.6	0.75	66
AE(S)(F)(P)4A771200BDL	7000	1,200	885	65	5.9	13	208	8.2	76	3.0	1	66
AE(S)(F)(P)4A773000BDL	7000	3,000	2,213	25	6.8	15	243	9.6	76	3.0	1	66
AE(S)(F)(P)4A884200B1DL	8000	4,200	3,100	12	10.4	23	289	11.4	86	3.6	1	66
AE(S)(F)(P)4A884200BDL	8000	4,200	3,100	12	10.4	23	289	11.4	86	3.6	1.5	66
AE(S)(F)(P)4A885000BDL	8000	5,000	3,700	9	10.4	23	280	11.4	86	3.6	1.5	66
AE(S)(F)(P)4A896500BDL	8000/9000	6,500	4,800	7	15.0	33	327	12.9	101	4.0	1.5	66
AE(S)(F)(P)(J)4A898100BDL*	8000/9000	8,100	6,000	5	15.0	33	327	12.9	101	4.0	1.5	66
AEF4A8X12000BDL*	8000/9000	12,000	8,850	3.5	22.3	48.5	475	19.0	131	5.2	1.5	66

- For Straight Type tools Choose the position of the handle by adding (L) for left side and (R) for right side

* 8,100 Nm and 12,000 Nm models are not supported by the Gen III controller platform. The Gen IV controller platform is required.

360° SWIVEL GEARCASE MODEL	SERIES	APPROX. TORQUE		APPROX. SPEED RPM	WEIGHT		LENGTH		DIA.		DRIVE IN	SOUND LEVEL dB(A)
		NM	FT-LB		KG	LB	MM	IN	MM	IN		
AE(S)(F)(P)4B66250BDL	6000	250	185	315	4.6	10.5	254	10	66	2.6	0.75	66
AE(S)(F)(P)4B66425BDL	6000	425	315	165	4.6	10.5	254	10	66	2.6	0.75	66
AE(S)(F)(P)4B66625BDL	6000	625	460	106	4.8	10.5	254	10	66	2.6	0.75	66
AE(S)(F)(P)4B66925BDL	6000	925	682	72	4.8	10.5	254	10	66	2.6	0.75	66
AE(S)(F)(P)4B771200BDL	7000	1,200	885	65	6.6	14.5	259	10.2	76	3.0	1	66
AE(S)(F)(P)4B773000BDL	7000	3,000	2,213	25	7.5	16.5	294	11.6	76	3.0	1	66
AE(S)(F)(P)4B884200B1DL	8000	4,200	3,100	12	11.1	24.5	340	13.4	86	3.6	1	66
AE(S)(F)(P)4B884200BDL	8000	4,200	3,100	12	11.1	24.5	340	13.4	86	3.6	1.5	66
AE(S)(F)(P)4B885000BDL	8000	5,000	3,700	9	11.1	24.5	340	13.4	86	3.6	1.5	66
AE(S)(F)(P)4B896500BDL	8000/9000	6,500	4,800	7	15.7	34.5	378	14.9	101	4.0	1.5	66
AE(S)(F)(P)(J)4B898100BDL*	8000/9000	8,100	6,000	5	15.7	34.5	378	14.9	101	4.0	1.5	66
AEF4B8X12000BDL*	8000/9000	12,000	8,850	3.5	23.0	51.0	526	21	131	5.2	1.5	66

- For Straight Type tools Choose the position of the handle by adding (L) for left side and (R) for right side

* 8,100 Nm and 12,000 Nm models are not supported by the Gen III controller platform. The Gen IV controller platform is required.



NOSE EXTENSIONS

FEATURES AND BENEFITS

- Ideal for hard-to-reach applications when a torque tube, or arm, is not desirable
- A cost-effective, more flexible option compared to a multiple spindle system
- Common applications:
 - Wheel install and repair stations
 - Large flange assembly
 - Mining vehicle shovel bolts
 - Railway equipment maintenance
 - Oil and gas industry well fixtures



28050



28480

HT GEARHEAD TOOLS

FEATURES AND BENEFITS

- Application-specific, custom made tools fit virtually any application
- Same durable gearing as found on AcraDyne's standard HT series tools
- Model types available:
 - HT Offset Gearhead tools
 - HT Right Angle with Offset Gearhead tools
 - HT Right Angle Air tools with Offset Gearhead

Custom accessories are available for your application. Contact an AIMCO Customer Service Associate for more details, 1-503-254-6600, or toll free 1-800-852-1368.



ACRADYNE HIGH TORQUE ACCESSORIES

ACCESSORIES

Custom accessories are available for your application; contact an AIMCO Customer Service Associate for details, 1-503-254-6600, or toll free 1-800-852-1368.







MODEL	DESCRIPTION
26477	Swivel Bail, 6000 Series
26327	Swivel Bail, 7000 Series
26630	Swivel Bail, 8000 Series
26478	Swivel D-Handle, 6000 Series
26328	Swivel D-Handle, 7000 Series
25291	Swivel D-Handle, 8000 Series
26479	Stationary Bail, 6000 series (26336 handle not included)
26332	Stationary Bail, 7000 series (26336 handle not included)
25289	Stationary Bail, 8000 series (26336 handle not included)
26336	Fixed Handle (for use with 26479, 26332, 25289)
26337	Rear Fixed Hoist Ring, 6000/7000/8000 Series Pistols
28514	Rear Folding Hoist Ring Kit for 8000 Series Pistols
28549	Sliding Spindle, 6000 Series
27045	Sliding Spindle, 7000 Series
30300	Sliding Spindle, 8000 Series

REACTION BARS



HT tool includes a standard, spline attachment reaction device. Custom reaction devices are available; contact an AIMCO Customer Service Associate for more details, 1-503-254-6600, or toll free 1-800-852-1368.

	MODEL	DESCRIPTION
 Single Ended Flat	26810	6000 Series
	26800	7000 Series
	25277	8000 Series
	27255	9000 Series
	30303	X Series
 Single Ended Offset	26815	2.375" Offset, 6000 Series
	26885	4.00" Offset, 6000 Series
	27200	3.10" Offset, 7000 Series
	26890	4.00" Offset, 7000 Series
	25274	3.35" Offset, 8000 Series
	25275	4.00" Offset, 8000 Series
	26840	3.35" Offset, 9000 Series
30306	5.00" Offset, X Series	
 Double Ended Flat	26830	6000 Series
	26820	7000 Series
	25278	8000 Series
 Double Ended Offset	25276	3.35" Offset, 8000 Series

PROTECTIVE COVERS



Durable protective covers prevent marring and damage.

MODEL	DESCRIPTION
BJ10078	Protective Cover, 6000 Series
BJ10077	Protective Cover, 7000 Series
BJ10076	Protective Cover, 8000 Series

DC TOOLS: TOOL/SPINDLE SELECTION GUIDE

MODEL	RPM**	LENGTH		WEIGHT		TORQUE, Nm																						
		IN	MM	LB	KG	5	10	15	20	25	50	75	100	125	150	175	200	225	250	275	300	325	350	375	400	425	450	
ANGLE																												
AEN4C12004B	3,111	11.65	295.9	2.0	0.91	█																						
AEN4C12009B	1,750	11.00	279.5	2.2	1.00	█	█																					
AEN4C12014B	875	11.66	296.4	2.2	1.00	█	█	█																				
AEN4C12018B	691	11.66	296.4	2.2	1.00	█	█	█	█																			
AEN4C12022B	560	11.66	296.4	2.2	1.00	█	█	█	█	█																		
AEN32015C	1,481	14.6	371.0	2.7	1.22		█	█																				
AEN32025C	833	14.6	371.0	2.7	1.22		█	█	█	█																		
AEN32030C	803	14.4	366.2	2.8	1.27		█	█	█	█	█																	
AEN32040C	574	14.4	366.2	2.8	1.27		█	█	█	█	█	█																
AEN33042C	1,095	16.6	422.3	4.4	2.00		█	█	█	█	█	█																
AEN33053C	1,095	16.6	422.3	4.4	2.00		█	█	█	█	█	█	█															
AEN33060C	845	18.9	480.5	6.6	2.99		█	█	█	█	█	█	█															
AEN33090C	568	18.9	480.5	6.6	2.99		█	█	█	█	█	█	█	█														
AEN33120C	442	21.0	533.5	9.3	4.22		█	█	█	█	█	█	█	█														
AEN33200C	245	23.2	589.6	9.4	4.26		█	█	█	█	█	█	█	█	█													
AEN33210C	234	23.6	599.9	10.0	4.54		█	█	█	█	█	█	█	█	█	█												
AEN33300C	151	23.6	599.0	10.0	4.54		█	█	█	█	█	█	█	█	█	█	█											
AEN33375C	151	23.6	599.0	10.0	4.54		█	█	█	█	█	█	█	█	█	█	█	█										
AEN35090B	607	22.6	573.7	6.9	3.13		█	█	█	█	█	█	█	█														
AEN35140B	472	22.5	571.9	10.4	4.72		█	█	█	█	█	█	█	█	█													
AEN35175B	384	22.5	571.9	10.5	4.76		█	█	█	█	█	█	█	█	█													
AEN35225B	291	22.9	581.1	12.3	5.58		█	█	█	█	█	█	█	█	█	█												
AEN35285B	236	22.9	581.1	12.3	5.58		█	█	█	█	█	█	█	█	█	█	█											
AEN35350B	191	22.9	581.1	12.3	5.58		█	█	█	█	█	█	█	█	█	█	█	█										
INLINE																												
AES4A12003BQ	2,625	11.12	282.7	2.0	0.91	█																						
AES4A12006BQ	2,625	11.12	282.7	2.0	0.91	█	█																					
AES4A12011BV	1,313	11.44	290.5	2.2	1.00	█	█	█																				
AES4A12014BV	1,037	11.44	290.5	2.2	1.00	█	█	█	█																			
AES4A12018BV	840	11.44	290.5	2.2	1.00	█	█	█	█	█																		
AES4A12022BV	656	11.44	290.5	2.2	1.00	█	█	█	█	█	█																	
AES32010CV	2,222	13.9	351.7	2.5	1.13	█	█																					
AES32020CV	1,250	13.9	351.7	2.5	1.13	█	█	█																				
AES32025CV	893	13.9	351.7	3.2	1.45	█	█	█	█																			
AES32038CV	595	16.7	424.0	4.2	1.91	█	█	█	█	█																		
AES33040CV	1,314	18.2	463.4	6.4	2.90	█	█	█	█	█																		
AES33060CV	883	18.2	463.4	6.4	2.90	█	█	█	█	█	█																	
AES33100CV	489	22.6	573.0	8.1	3.67	█	█	█	█	█	█																	
AES33150CV	329	22.6	573.0	8.1	3.67	█	█	█	█	█	█	█																
AES33230CV	221	22.6	573.0	8.1	3.67	█	█	█	█	█	█	█	█															
AES33230C-2	221	22.6	573.0	8.1	3.67	█	█	█	█	█	█	█	█	█														
AES33400CV	122	24.9	632.5	13.0*	5.90*	█	█	█	█	█	█	█	█	█	█	█	█	█	█	█	█	█	█	█	█	█	█	█
AES33600CV**	82	24.9	632.5	13.0*	5.90*	█	█	█	█	█	█	█	█	█	█	█	█	█	█	█	█	█	█	█	█	█	█	█
AES35075AV	944	21.9	555.2	9.2	4.17		█	█	█	█	█	█	█	█														
AES35090AV	767	21.9	555.2	9.2	4.17		█	█	█	█	█	█	█	█	█													
AES35110AV	634	21.9	555.2	9.2	4.17		█	█	█	█	█	█	█	█	█													
AES35135AV	515	21.9	555.2	9.2	4.17		█	█	█	█	█	█	█	█	█	█												
AES35170AV	418	21.9	555.2	9.2	4.17		█	█	█	█	█	█	█	█	█	█												
AES35280A	236	24.2	615.1	12.8	5.81		█	█	█	█	█	█	█	█	█	█	█											
AES35350A	192	24.2	615.1	12.8	5.81		█	█	█	█	█	█	█	█	█	█	█	█										
AES35420A	159	24.2	615.1	12.8	5.81		█	█	█	█	█	█	█	█	█	█	█	█	█									
AES35515A***	129	24.2	615.1	12.8	5.81		█	█	█	█	█	█	█	█	█	█	█	█	█	█								
AES35635A****	104	24.2	615.1	12.8	5.81		█	█	█	█	█	█	█	█	█	█	█	█	█	█	█							

* Includes reaction bar and fixture nut.

** Torque Range: 120-480 Nm Max Torque: 600 Nm

*** Torque Range: 128-515 Nm

**** Torque Range: 159-635 Nm

Recommended Torque Range

Max Torque

Continued on next page

DC TOOLS: TOOL/SPINDLE SELECTION GUIDE

MODEL	RPM**	LENGTH		WEIGHT		TORQUE, Nm																					
		IN	MM	LB	KG	5	10	15	20	25	50	75	100	125	150	175	200	225	250	275	300	325	350	375	400	425	450
PISTOL																											
AEP4_12003B	2,625	7.3	186.3	2.2	1.00																						
AEP4_12006B	2,625	7.3	186.3	2.2	1.00																						
AEP4_12011BV	1,313	8.0	203.3	2.3	1.04																						
AEP4_12014BV	1,037	8.0	203.3	2.3	1.04																						
AEP4_12018BV	840	8.0	203.3	2.3	1.04																						
AEP4_12022BV	656	8.0	203.3	2.3	1.04																						
AEP4_22020BV	1,313	8.7	219.9	2.4	1.09																						
AEP4_22025BV	1,037	8.7	219.9	2.4	1.09																						
AEP4_22030BV	840	8.7	219.9	2.4	1.09																						
AEP4_22035BV	747	8.7	219.9	2.4	1.09																						
AEP4_22040BV	656	8.7	219.9	2.4	1.09																						
AEP35075AV	944	16.0	405.2	9.2	4.17																						
AEP35090AV	767	16.0	405.2	9.2	4.17																						
AEP35110AV	634	16.0	405.2	9.2	4.17																						
AEP35135AV	515	16.0	405.2	9.2	4.17																						
AEP35170AV	418	16.0	405.2	9.2	4.17																						
AEP35280A	236	18.4	468.2	13.6	6.17																						
AEP35350A	192	18.4	468.2	13.6	6.17																						
AEP35420A	159	18.4	468.2	13.6	6.17																						
AEP35515A*	129	18.4	468.2	13.6	6.17																						
AEP35635A**	104	18.4	468.2	13.6	6.17																						
TUBENUT																											
AET4A12018B	516	15.41	288.1	3.1	1.41																						
AET4A12025B	387	15.41	288.1	3.1	1.41																						
AET4A12025B-KD	387	15.9	404.9	3.1	1.41																						
AET32020C	622	17.2	436.4	3.1	1.41																						
AET32025C	466	17.8	450.9	4.0	1.81																						
AET32035C	347	18.1	460.5	4.5	2.04																						
AET32050C	257	18.8	478.0	5.6	2.54																						

* Torque Range: 128 - 515 Nm
 ** Torque Range: 159 - 635 Nm



HIGH TORQUE SERIES

MODEL	RPM**	LENGTH		WEIGHT		TORQUE, Nm																					
		IN	MM	LB	KG	50	100	200	300	400	500	600	850	1100	1200	1300	1500	2000	2500	3000	4000	5000	6500	8100	12000		
()4(A)(B)66200B	315	12	305	12	5.3																						
()4(A)(B)66425B	165	12	305	12	5.3																						
()4(A)(B)66625B	106	12	305	12	5.5																						
()4(A)(B)66925B	72	12	305	12	5.5																						
()4(A)(B)771200B	65	12.2	310	16	7.3																						
()4(A)(B)773000B	25	13.6	345	18	8.2																						
()4(A)(B)884200B1	12	15.4	391	26	11.8																						
()4(A)(B)884200B	12	15.4	391	26	11.8																						
()4(A)(B)885000B	9	15.4	391	26	11.8																						
()4(A)(B)896500B	7	16.9	429	36	16.4																						
()4(A)(B)898100B	5	16.9	429	36	16.4																						
()4(A)(B)8X12000B	3.5	22	564	52.5	24.0																						

Recommended Torque Range

Max Torque

ACRADYNE ACCESSORIES

CABLE ASSEMBLIES

The AcraDyne DC electric nutrunner tool system uses a single cable to carry all necessary conductors for superior ergonomics and durability.

- Flexible polyurethane cover for maximum durability, abrasion and transmission fluid resistant
- Quick disconnects at both ends facilitate tool changeover and troubleshooting
- The CAN data/signal is via RJ45 for products such as the KDM, socket tray or computer



MODEL	DESCRIPTION	LENGTH	
		M	FT
TOOL CABLES			
24330	Cable G3 Tool Cable 3M	3	9.8
25350	Cable G3 Tool Cable 5M	5	16.4
24320	Cable G3 Tool Cable 10M	10	32.8
27110	Cable G3 Tool Cable 3M Lightweight*	3	9.8
27115	Cable G3 Tool Cable 5M Lightweight*	5	16.4
27122	Cable G3 Tool Cable 10M Lightweight*	10	32.8
EXTENSIONS			
24320	Extension cable 10M	10	32.8
25518	Extension cable 20M	20	65.6

*Lightweight cables are for use only with 1000 & 2000 Series tools.

CABLE ADAPTERS AND CONNECTORS

	MODEL	DESCRIPTION
ADAPTERS AND CONNECTORS		
	25646	G1 iEC to G3 Cable Adapter
	26934	G3 iEC to G1 Cable Adapter
	27210	G3 Tool to G1 Cable Adapter
	26364	Right Angle Cable Adapter
	26594	Conversion Kit G1 iEC to G3 iEC
	27370	Conversion Kit G3 iEC to G1 iEC
	25491	Breakaway Cable Connector - Ensures disconnect of cable should stress in excess of 40 lbs. occur
	30355	Y Cable Harness connects G4 iAC controller and controller's I/O to tool's EC/MCCBL cable. Compatible with UA-40S(D)MC, UA-50S(D)MC, UA-60S(D)MC, UA-70SMC, and UA-150MC tools.

DATA INTERFACE OPTION

	MODEL	DESCRIPTION
DATA INTERFACE OPTIONS		
	27348	I/O Wiring Connector - Simple module to facilitate connections to I/O on iEC Controllers
	28292	System Port Cable, USB 2.0 Cable, A Male to B Male, 3M

CABLE TESTER UNIT

AcraDyne's Cable Tester Unit helps diagnose and verify functionality of AcraDyne Tool Cables.

- Eliminate guesswork as to whether cable is damaged or is functioning within specifications
- Verifies each specific conductor within the cable for continuity

	MODEL	DESCRIPTION
	26700	Cable Tester Unit, G3
	26709	Adapter, G3 Tool to G1 Cable (Cable Tester only)

ACRADYNE ACCESSORIES



30850 FRL Assembly Kit

FRL ASSEMBLY KIT

For use with the iAC controller, AcraDyne's FRL assembly kit includes a regulator and solenoid. The kit attaches to the controller or can operate as a stand-alone unit.



SOCKET TRAY

Socket trays, for use with iEC and UEC Controllers, are supplied with blank socket pucks machined to fit specific sockets for the application. AIMCO provides this machining as an additional service. When ordering, please specify the outer dimensions of the sockets you plan to use, and whether you would like a quote for the machining service.

- Simply remove the assigned socket to select the application to be run
- Quick and easy set up. Parameters assigned to socket position automatically
- Optional self-illuminating socket receptacles
- Delrin® blanks may be easily machined by the customer to accommodate custom socket profiling
- Nothing to break, wear out, or maintain
- Proximity sensors detect presence of socket



MODEL	DESCRIPTION
AMPST-2-I	2-Position Socket Tray for iEC Controllers, 2 x 1, 1.25" Socket
AMPST-2-U	2-Position Socket Tray for UEC Controllers, 2 x 1, 1.25" Socket
AMPST-4-I	4-Position Socket Tray for iEC Controllers, 2 x 2, 1.25" Socket
AMPST-4-U	4-Position Socket Tray for UEC Controllers, 2 x 2, 1.25" Socket
AMPST-6S-I	6-Position Socket Tray for iEC Controllers, 6 x 1, 1.25" Socket
AMPST-6S-U	6-Position Socket Tray for UEC Controllers, 6 x 1, 1.25" Socket
AMPST-6-I	6-Position Socket Tray for iEC Controllers, 3 x 2, 1.25" Socket
AMPST-6-U	6-Position Socket Tray for UEC Controllers, 3 x 2, 1.25" Socket
AMPST-8-I	8-Position Socket Tray for iEC Controllers, 4 x 2, 1.25" Socket
AMPST-8-IL	8-Position Socket Tray for iEC Controllers, 4 x 2, 2.0" Socket
AMPST-8-U	8-Position Socket Tray for UEC Controllers, 4 x 2, 1.25" Socket

Socket trays with 6 - 8 positions are available in varied configurations to suit workspace requirements (straight or double rows). Please let your AIMCO representative know of your specific requirements when inquiring.

ACRADYNE ACCESSORIES

BAR CODE SCANNER



28859
Bluetooth®-Enabled Scanner Kit

Sturdy bar code scanners allow you to easily scan small, stacked, or poorly printed, one-dimensional bar codes. Kit includes a cradle, power supply, and USB/Ethernet cable.

- Scratch proof, tempered glass exit window
- Single-circuit board construction eliminates common interconnection failures
- Industrial long-life charging contacts can withstand 250,000+ insertions into cradle
- Wireless scanner enables users to hold scanner at any angle

MODEL	DESCRIPTION
20400	RS232 Barcode Reader Kit
28859	RS232 Wireless Barcode Reader Kit



23730

LIGHT TOWER

Cost- and energy-efficient LED light tower is visible from any direction, angle, and distance

- Two built-in alarms (FB Type) with selectable sound patterns
- Adjustable Volume (Max. 85 dB at 1 m)
- Tower includes red, yellow, green, blue, and clear lenses



28489 Light Tower Bracket for Gen IV Controller

ANGLE TOOL BODY JACKETS

Keep tools protected with AIMCO's tool Body Jackets.



MODEL	DESCRIPTION
BJ10051	For 1000 series angle tools
BJ10052	For 2015, 2025 series angle tools
BJ10053	For 2030, 2040, 2055 series angle tools
BJ10054	For 3060, 3090 series angle tools
BJ10055	For 3120, 3200 series angle tools

TOOL STORAGE

Tool baskets and tool hangers are a great way to keep a tool in place when not being used.

UNIVERSAL TOOL BASKET

Interchangeable among angle head and pistol grip tool models throughout the industry.



21226

VERTICAL TOOL HANGER

Designed for AcraDyne Gen 1 tools.



21159

ACRADYNE ACCESSORIES

CONTROLLER BRACKETS



20322

20853

27816











MODEL	DESCRIPTION
20322	Basic wall-mounting plate
20853	Table stand free standing platform
27816	Mounting bracket with internal wireways

TOOL BAILS

- AcraDyne's spring bails are designed for use with any of the AcraDyne 1000, 2000, or 3000 Series tools
- Spring bails snap on quickly and firmly at any place on the body of the tool for perfect balance and secure suspension

MODEL	DESCRIPTION
 25501	Wire Bail for 1000 Series Tools
 27594	Stationary Bail for 1000 Series Tools
 27791	Rotating Bail Assembly for 1000 Series Tools
 26568	Cable Bail to Hang Tool Vertically for Gen III Cables
 21208	Spring Bail for 2000 Series Tools
 23662	Rotating Bail for 2000 Series Tools
 28475	Rotating Bail for AEN33042C and AEN33053C
 23575	Rotating Bail for 3000 Series Tools

MOUNTING BRACKETS

MODEL	DESCRIPTION
 25717	Mounting Bracket for 1000 Series Angle Tools
 25843	Mounting Bracket for 1000 Series Push-To-Start Tools
 26443	Mounting Bracket for 1000/2000 Series Straight and Pistol Tools
 24924	Mounting Flange for 1000/2000 Series Straight and Pistol Tools
 28622	Mounting Flange for 2000 Series Inline Tools
 30340	Mounting Bracket for 2000 Series Angle Tools
 30351	Mounting Bracket, Drive End for 2000 Series Inline Tools
 25718	Mounting Bracket for 3000/5000 Series Angle Tools
 26570	Mounting Bracket for 3000/5000 Series Straight Tools
 25265	Angle head Mounting Bracket (Cradle type) for 3000/5000 Angle Tools over 225 Nm
 26394	Mounting Flange for 5000 Series

ACRADYNE CORDLESS TOOLS

WORK SMARTER, NOT HARDER

AcraDyne AB-CTA and AB-MTA Cordless Series: Intelligent Tools in a Powerful Package

AcraDyne's high-performance cordless tools are Transducerized for precise delivery of torque and angle to the fastener. High sensor precision guarantees exact and repeatable torque every time, ensuring you meet your most important goal – creating a quality product.

The tools are available in two model types – the standard AB-CTA model that *controls* Torque and Angle, and the AB-MTA clutch shut-off model that *measures* torque AND angle.



FEATURES AND BENEFITS OF ALL AB TOOLS

- Self-contained with on-board control
 - Can run autonomously or with iBC ACE controller
- Load tool programming software through USB cable interface
- Vibration alarm handle provides tactile feedback
- Programmable
 - Torque
 - Angle
 - RPM
 - Time
 - Fastening direction
- 100 PSET
- Six step, multi-stage job functionality
- Multicolor LED status screen
- 150,000 results stored on-board



Multicolor LED
Status Screen

AB-CTA SERIES ADDITIONAL FEATURES

- Torque Ranges:
 - Pistol Tool: 1.5–17 Nm
 - Straight Tool: 1.5–17 Nm
 - Angle Tool: 1.5–130 Nm
 - Tubenut Tool: 5–20 Nm

AB-MTA SERIES ADDITIONAL FEATURES

- Torque Ranges:
 - Pistol Tool: 1.0–17 Nm
 - Straight Tool: 1.0–17 Nm
 - Angle Tool: 2.5–10 Nm

(up to 105 Nm coming soon)
- Clutch shutoff
 - Accurate
 - Fast: Allows tool to run at high speed with minimal overshoot
 - Ergonomic: Significantly reduced reaction to the operator

ACRADYNE CORDLESS TOOLS



AB-CTA SERIES

MODEL	TORQUE RANGE		MAX SPEED RPM	DRIVE TYPE	WEIGHT W/O BATTERY	
	NM	FT-LB			KG	LB
PISTOL						
ABP-CTA12Q(WQ)(BQ)(WBQ)	1.5 - 12	1.1 - 8.9	570	1/4" QC	1.15	2.5
ABP-CTA17Q(WQ)(BQ)(WBQ)	3.0 - 17	2.2 - 12.5	460	1/4" QC	1.15	2.5
STRAIGHT						
ABS-CTA12Q(WQ)(BQ)(WBQ)	1.5 - 12	1.1 - 8.9	570	1/4" QC	0.95	2.1
ABS-CTA17Q(WQ)(BQ)(WBQ)	3.0 - 17	2.2 - 12.5	460	1/4" QC	0.95	2.1
ANGLE						
ABN-CTA10(W)(B)(WB)	1.5 - 10	1.1 - 7.4	570	3/8" Sq.	1.35	3.0
ABN-CTA17(W)(B)(WB)	2.5 - 17	1.8 - 12.5	380	3/8" Sq.	1.4	3.1
ABN-CTA24(W)(B)(WB)	5.0 - 24	3.7 - 17.7	300	3/8" Sq.	1.2	2.6
ABN-CTA36(W)(B)(WB)	8.0 - 36	5.9 - 26.6	170	3/8" Sq.	1.2	2.6
ABN-CTA55(W)(B)(WB)	15.0 - 55	11.1 - 40.6	90	3/8" Sq.	1.4	3.1
ABN-CTA105(W)(B)(WB)	25.0 - 105	18.4 - 77.4	60	1/2" Sq.	2.9	6.4
ABN-CTA130(W)(B)(WB)	35.0 - 130	25.8 - 95.9	50	1/2" Sq.	3.1	6.8
TUBENUT						
ABT-CTA20W	5.0 - 20	3.7 - 14.8	300	3/8" Sq.	1.2	2.6

W = WiFi option B = Barcode option Q = Quick Change

AB-MTA SERIES

MODEL	TORQUE RANGE		MAX SPEED RPM	DRIVE TYPE	WEIGHT W/O BATTERY	
	NM	FT-LB			KG	LB
PISTOL						
ABP-MTA06(Q)(WQ)(BQ)(WBQ)	1.0 - 6	0.8 - 4.4	1,050	1/4" QC	1.25	2.75
ABP-MTA08(Q)(WQ)(BQ)(WBQ)	1.5 - 8	1.1 - 5.9	900	1/4" QC	1.25	2.75
ABP-MTA12(Q)(WQ)(BQ)(WBQ)	2.3 - 12	1.7 - 8.9	600	1/4" QC	1.25	2.75
ABP-MTA17(Q)(WQ)(BQ)(WBQ)	3.5 - 17	2.6 - 12.5	460	1/4" QC	1.25	2.75
STRAIGHT						
ABS-MTA06(Q)(WQ)(BQ)(WBQ)	1.0 - 6	0.8 - 4.4	1,050	1/4" QC	1.0	2.2
ABS-MTA08(Q)(WQ)(BQ)(WBQ)	1.5 - 8	1.1 - 5.9	900	1/4" QC	1.0	2.2
ABS-MTA12(Q)(WQ)(BQ)(WBQ)	2.3 - 12	1.7 - 8.9	600	1/4" QC	1.1	2.4
ABS-MTA17(Q)(WQ)(BQ)(WBQ)	3.5 - 17	2.6 - 12.5	460	1/4" QC	1.25	2.75
ANGLE						
ABN-MTA10(W)(B)(WB)	2.5 - 10	1.9 - 7.4	570	1/4" Sq.	1.35	3.0

Angle Tools 17 - 105 Nm coming soon

W = WiFi option B = Barcode option Q = Quick Change



For simple adjustment, the MTA series provides easy clutch access.

ACRADYNE CORDLESS TOOLS

BATTERIES

- Up to 40% lighter than Ni-MH batteries
- Deep-discharge protection prevents battery failure



AB-B1825LI



AB-B1850LI

BATTERY MODEL #	VOLTAGE	TYPE	CAPACITY	WEIGHT
AB-B1825LI	18V	Li-Ion	2.5 Ah	.8 Lb/.35 kg
AB-B1850LI	18V	Li-Ion	5.0 Ah	1.3 Lb/.6 kg



AB-C18110

BATTERY CHARGERS

- Battery defect detection
- Microprocessor-controlled charging: Charging time is dependent on the capacity of the battery
- Reverse polarity protection
- Automatic battery voltage detection
- Multi-bay charger includes battery adapters



AB-C18-4W

MODEL	DESCRIPTION	OUTPUT	INPUT	CHARGING TIME	DIMENSIONS (W/O BATTERY)	WEIGHT
AB-C18110	Quick-charge unit for 110V	14.4V - 18V, 3.0A	110VAC, 50-60Hz	Max 55 min for 2.5 Ah battery	3.39" (W) x 4.21" (H) x 6.02" (D) 86 mm (W) x 107 mm (H) x 153 mm (D)	1.2 Lb/.55 kg
AB-C18220	Quick-charge unit for 220V	14.4V - 18V, 3.0A	220-240VAC, 50-60Hz	Max 55 min for 2.5 Ah battery	3.39" (W) x 4.21" (H) x 6.02" (D) 86 mm (W) x 107 mm (H) x 153 mm (D)	1.2 Lb/.55 kg
AB-C18-4W	4-bay charge unit for 100-240VAC	14.4V - 18V, 3.0A	100-240VAC, 50-60Hz	Max 55 min for 2.5 Ah battery	21.2" (W) x 7.2" (H) x 10.2" (D) (incl. feet) 539 mm (W) x 182 mm (H) x 260 mm (D) (incl. feet)	16.8 Lb/7.6 kg

TOOL DIMENSIONS

MODEL	A		B		C		D		E	
	IN	MM	IN	MM	IN	MM	IN	MM	IN	MM
PISTOL										
All Models	9.1	230	1	26	8.6	218	4.5	115	-	-
STRAIGHT										
All Models	17.2	437	3.2	81	0.8	20	4.5	115	-	-
ANGLE										
ABN-(MTA)(CTA)10(W)(B)(WB)	17.8	451	3.7	95	1.3	33	4.5	115	0.8	21
ABN-CTA17(W)(B)(WB)	17.8	451	3.7	95	1.3	33	4.5	115	0.8	21
ABN-CTA24(W)(B)(WB)	17.8	451	3.7	95	1.3	33	4.5	115	0.8	21
ABN-CTA36(W)(B)(WB)	20.6	523	6.8	173	1.7	42	4.5	115	1.1	29
ABN-CTA55(W)(B)(WB)	22	559	8.2	209	1.7	42	4.5	115	1.1	29
ABN-CTA105(W)(B)(WB)	25.7	653	11.9	303	1.9	49	4.5	115	1.4	35
ABN-CTA130(W)(B)(WB)	28.1	715	14.4	365	2.8	71	4.5	115	2.1	54
TUBENUT										
ABT-CTA20W	23	582	8.4	213	4.7	121	4.5	115	0.6	14

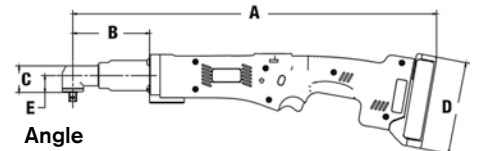
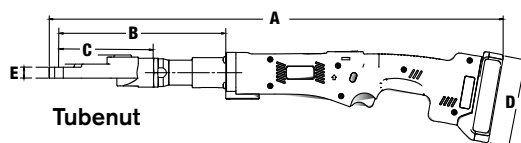
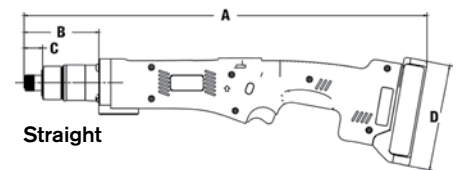
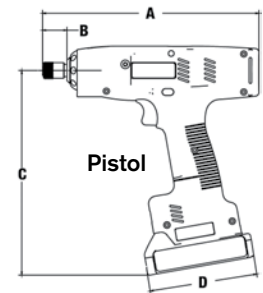

ACRADYNE SYSTEMS



MULTIPLE NUTRUNNING SYSTEMS

AIMCO can integrate the AcraDyne tool spindle into a customized Multiple Nutrunning system. From simple systems vertically suspended above the part, to assembly stations that integrate with your line, AIMCO can effectively accommodate your project.

LET US KNOW YOUR REQUIREMENTS AND WE WILL PROPOSE A SOLUTION TAILORED TO YOUR NEEDS.



FEATURES AND BENEFITS

- Nutrunner sequencing - Allows nutrunners to be sequenced at each phase of the tightening process, providing even distribution of torque and load to each fastener. This prevents part damage and distortion
- Snug threshold, final torque in one pass - No need for multiple torque stage sequencing. Fixtured nutrunners save time and effort
- No missed fasteners - Multiple nutrunners have a spindle dedicated to each location, ensuring quality on every rundown on every bolt
- Better residual torques - Synchronized controlled fastening allows residual torque levels to be consistent with the dynamic torque specification
- Saving in cycle time - Compared to using a single nutrunner tool with many rundowns, running all fasteners simultaneously reduces in-station cycle time
- Cost saving benefits - Saving installation cycle time frees operators to handle additional tasks and potentially reduce labor costs
- Collect data – Most common methods of collecting data for quality control and statistical analysis can be implemented from a serial data string using RS232 to formatted data from a network database

INDUSTRY APPLICATIONS

- Harvester chain-pull assembly, 2-spindle
- Engine flywheel assembly, 3-spindle
- Wheel lug nut assembly, 4-spindle
- Axle u-bolt assembly, 4-spindle
- Gasoline generator assembly, 6-spindle
- Lawn mower motor assembly, 7-spindle
- Air-cooled small vehicle engine assembly, 10-spindle

TOOL SPECIALS



AIMCO can provide customized tooling solutions for even the most unique applications. Let us propose a solution tailored to your needs. Contact an AIMCO Customer Service Associate for more details, 1-503-254-6600, or toll free 1-800-852-1368.



ACRADYNE HIGH TORQUE PNEUMATIC TOOLS

FEATURES AND BENEFITS

AcraDyne's High Torque Pneumatic Bolting Tools offer a reliable and dependable solution for the installation and removal of heavy-duty fasteners. Appropriate for use in industries requiring high torque capability, accuracy, power, and safety.

- Modular design allows for ease of maintenance
- Interchangeable motors and gearing
- Same proven and reliable gearbox as the AcraDyne DC line
- One-hand reverse



AAP1B66600A



AAP1B76950A



AAP1B772000A



AAP1B885100A



MODEL	TORQUE		SPEED (RPM)	WEIGHT (LB)	SQUARE DR. (IN)	AIR CONSUMPTION (CFM)
	(NM)	(FT-LB)				
AAP1B66400A	400	300	57	9.75	3/4	22.9
AAP1B66600A	600	450	39	9.75	3/4	22.9
AAP1B66850A	850	625	27	9.75	3/4	22.9
AAP1B76950A	950	700	31	10.4	3/4	26.3
AAP1B771350A	1,350	1,000	22	10.4	1	26.3
AAP1B772000A	2,000	1,475	14	12.7	1	26.3
AAP1B772950A	2,950	2,175	9	14.9	1	26.3
AAP1B885100A	5,100	3,775	8	23	1-1/2	31.5

AIR PREPARATION UNITS

Many stacking filter/regulator combinations are available. See page 45 for options.



AFRL-4



**AFRL-4HTA
Standalone Unit**

**28178
HT Air Tool/AFRL
Carrying Kit**



ACRADYNE HIGH TORQUE HIGH-SPEED PNEUMATIC TOOLS

Our High-Torque High-Speed Pneumatic Bolting Tools offer a reliable and dependable solution for the installation and removal of heavy-duty fasteners with high torque capability, accuracy, power, and safety.

FEATURES AND BENEFITS

- Dual motor design provides extremely fast rundown speed
- Improved torque to weight ratio
- Full swivel gearcase facilitates reaction bar positioning for ease of use and operator comfort
- Handle exhaust with low sound level
- Uses the same durable and reliable gearbox from our DC line of high torque tools
- Modular design allows for easy maintenance
- Two-piece handle construction enables flexible handle design
- Available in reversible and non-reversible models



MODEL	TORQUE		SPEED (RPM)	WEIGHT		LENGTH		SQUARE DR. (IN)
	(NM)	(FT-LB)		(LB)	(KG)	(IN)	(MM)	
AAP2B76250A	250	185	660	10.5	4.8	10	255	3/4
AAP2B76450A	450	330	335	10.5	4.8	10	255	3/4
AAP2B76650A	650	480	223	10.5	4.8	10	255	3/4
AAP2B76950A	950	700	153	10.5	4.8	10	255	3/4
AAP2B771400A	1,400	1,000	110	14.6	6.6	10	255	1
AAP2B772000A	2,000	1,475	63	14.8	6.7	11.2	284	1
AAP2B773000A	3,000	2,210	52	15.0	6.8	11.6	293	1
AAP2B785100A	4,800	3,540	26.5	19.7	8.9	13.3	338	1.5

REVERSIBLE MODEL	TORQUE		SPEED (RPM)	WEIGHT		LENGTH		SQUARE DR. (IN)
	(NM)	(FT-LB)		(LB)	(KG)	(IN)	(MM)	
AAP2B76250AR	250	185	660	12.3	5.6	12.5	317	3/4
AAP2B76450AR	450	330	335	12.3	5.6	12.5	317	3/4
AAP2B76650AR	650	480	223	12.3	5.6	12.5	317	3/4
AAP2B76950AR	950	700	153	12.3	5.6	12.5	317	3/4
AAP2B771400AR	1,400	1,000	110	16.4	7.4	12.6	319	1
AAP2B772000AR	2,000	1,475	63	16.6	7.5	13.6	346	1
AAP2B773000AR	3,000	2,210	52	16.8	7.6	14.0	356	1
AAP2B785100AR	4,800	3,540	26.5	21.5	9.7	15.8	400	1.5

ACRADYNE HT PNEUMATIC TOOL ACCESSORIES

Polyurethane Hose for HT Tools



ASH-500C-15MSZ

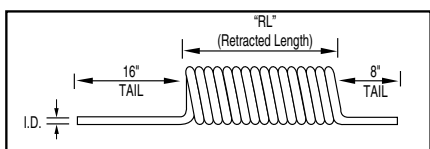

Custom length coil assemblies and special colors available in minimum order quantities. Contact an AIMCO Customer Service Associate, 1-503-254-6600, or toll free 1-800-852-1368.

- Durable Polyurethane is chemical resistant and lightweight, and provides excellent recoil memory and maximum flexibility
- Available in transparent hose color (opaque also available)
- Assemblies for coiled hose include reusable swivel fitting. Straight hose available with or without fittings
- Working temperature: -104°F to 175°F
- Working pressure: 100 PSI

SINGLE AIR HOSE ASSEMBLIES (COILED)

MODEL	DESCRIPTION (O.D. x I.D. x LENGTH)	RETRACTED LENGTH	NPT FITTINGS
ASH-500C-15MSZ	3/4" x 1/2" x 15'	13"	1/2"
ASH-500C-25MSZ	3/4" x 1/2" x 25'	23"	1/2"



STRAIGHT AIR HOSE (SOLD PER FOOT)

MODEL	DESCRIPTION
ASH-500Z	1/2" I.D.

Contact an AIMCO Customer Service Associate about full reel pricing, 1-503-254-6600, or toll free 1-800-852-1368.

Rubber Hose for HT Tools



28796
1/2" ID

- Designed for use in a wide range of industrial, construction, and agricultural applications
- Constructed of high grade, reinforced EPDM synthetic rubber
- Working temperature: -40°F to 190°F

SINGLE AIR HOSE (RUBBER)

I.D.	O.D.	LENGTH	WORKING PRESSURE	WEIGHT
1/2"	0.81"	10 ft	200 psi	2.0 lb
5/8"	0.97"	10 ft	200 psi	2.7 lb
3/4"	1.12"	10 ft	200 psi	3.4 lb

Custom lengths available. Contact an AIMCO Customer Service Associate for more details, 1-503-254-6600, or toll free 1-800-852-1368.

REACTION BARS

Tool includes standard, spline attachment reaction device. See page 29 for part numbers. Custom reaction devices are available; contact an AIMCO Customer Service Associate for more details, 1-503-254-6600, or toll free 1-800-852-1368.



Reaction Bars

Air Line Fittings



PLUGS

MODEL	DESCRIPTION
28161	1/2" x 1/4" MPT
28162	1/2" x 3/8" MPT
28163	1/2" x 1/2" MPT
28164	1/2" x 1/2" FPT



QUICK-CHANGE COUPLERS

MODEL	DESCRIPTION
27768	1/2" FPT
27769	1/2" MPT



PROTECTIVE COUPLER

MODEL	DESCRIPTION
27771	Vinyl



SWIVEL FITTING

MODEL	CAPACITY
500-SZ	1/2" NPT Swivel Fitting

HIGH TORQUE BATTERY TOOLS

AcraDyne's High Torque Battery Tools provide plenty of power in a compact package. The tool's low weight and ergonomic design ensure excellent mobility, flexibility, and efficiency, even when working in limited spaces. The low-wear brushless synchronous motor is maintenance free, reducing running costs.

FEATURES AND BENEFITS

- Battery driven two-speed torque multiplier for torques from 90 Nm to 4,000 Nm (65 to 2,950 ft-lb)
- Short fastening cycles: Fast gear for run down and power gear for highest torques and precision
- Mobile and always ready for use: Compact design for convenient use in limited spaces
- Efficient operation: Fast and easy gear-changing, great torque range – choose from 22 torque values
- Very low susceptibility to damage and failure: Motor housing made of special polymer that is break-proof, impact-proof, and resistant to corrosion
- Intelligent energy management and faster workflow: Electronics protect battery cells from overcharging and depth discharge



PERQ Advantages

PRODUCTIVITY • Two Lithium-Ion battery packs ensure up to 360 tightenings. Each battery features an LED charge level indicator

ERGONOMICS • Low weight relative to the torque delivered
• Ergonomically designed
• Low noise emissions

RELIABILITY • Low-wear brushless, synchronous motor is maintenance free

QUALITY • Exact shut-off torque even at low battery levels



Each tool comes with two 18 V, 5.2 Ah lithium-ion batteries and a battery charger. Battery and charger are also available to purchase separately.

Battery: ABG-B1852
110V Charger: ABG-C110
220V Charger: ABG-C220

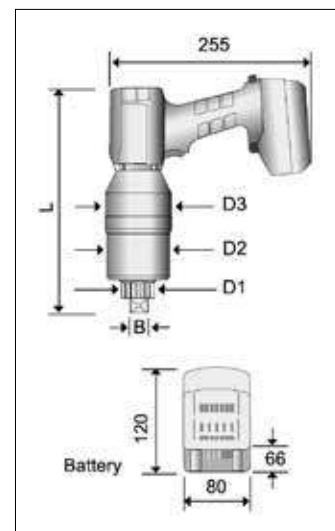

MODEL*	TORQUE RANGE**		SQ. DRIVE IN	DIAMETER			LENGTH		WEIGHT		IDLE SPEED (RPM)	
	NM	FT-LB		D ₁	D ₂	D ₃	IN	MM	LB	KG	1ST GEAR	2ND GEAR
ABG860-KIT	115 - 860	85 - 635	3/4	41 mm / 1.6 in	85 mm / 3.3 in	88 mm / 3.5 in	11.6	295	12.1	5.5	7.0	24.0
ABG1400-KIT	150 - 1,400	110 - 1,030	3/4	41 mm / 1.6 in	85 mm / 3.3 in	88 mm / 3.5 in	11.6	295	12.1	5.5	4.0	13.0
ABG2200-KIT	250 - 2,200	185 - 1,620	1	54 mm / 2.1 in	85 mm / 3.3 in	88 mm / 3.5 in	12.6	320	15.4	7.0	2.0	6.5
ABG2800-KIT	300 - 2,800	220 - 2,065	1	54 mm / 2.1 in	85 mm / 3.3 in	88 mm / 3.5 in	13.6	345	16.3	7.4	1.7	6.0
ABG3200-KIT	360 - 3,200	265 - 2,360	1	72 mm / 2.8 in	93 mm / 3.7 in	97 mm / 3.8 in	14.6	370	16.3	7.4	1.5	5.0
ABG4100-KIT	500 - 4,100	370 - 3,025	1-1/2	72 mm / 2.8 in	93 mm / 3.7 in	97 mm / 3.8 in	14.6	370	20.1	9.1	1.0	4.0

* Each tool comes in a kit, which includes the tool, two 18V / 5.2 Ah Li-ion batteries, and a battery charger.

** When loosening bolts, a higher torque (up to 20%) may be necessary (release torque).

AIR PREPARATION UNITS

AFRL STACKING FILTER/REGULATORS

Stacking filter/regulator combinations provide air filtration and precise regulation in a single unit for easy mounting and installation.

FEATURES AND BENEFITS

- All models include L-mount bracket, gauge, and metal bowl shields
- Polycarbonate filter and lubricator bowls (metal bowls standard on AFRL-8)
- 25-micron filter included on all models
- Regulating range: 7 – 125 PSI
- Custom order upgrade items include metal bowl, 5 micron filter, semi-automatic filter drain, and reduced PSI range regulator. Contact an AIMCO Customer Service Associate for more information, 1-503-254-6600, or toll free 1-800-852-1368



AFRL-2-C
AFRL-3-C

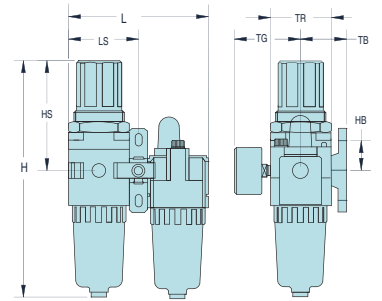

AFRL-3
AFRL-4
AFRL-8

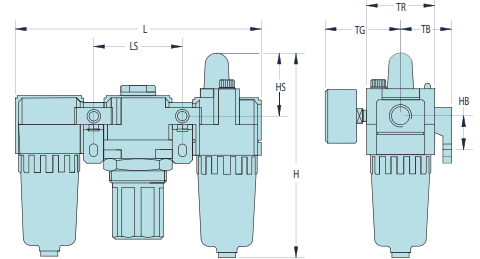

28178
HT Air Tool/AFRL
Carrying Kit

AFRL-4HTA
Standalone Unit



MODEL	PORT	GAUGE PORT	FLOW RATE CFM	FLOW RATE L/MIN	BOWL SHIELD	H IN/MM	HB IN/MM	HS IN/MM	L IN/MM	LS IN/MM	TB IN/MM	TG IN/MM	TR IN/MM
AFRL-2	1/4"	1/8"	70	2,000	yes	6.16 (156.5)	1.39 (35.3)	1.50 (38.1)	7.13 (181.1)	2.52 (64.0)	1.61 (41.0)	2.39 (60.7)	2.09 (53.1)
AFRL-2-C	1/4"	1/8"	60	1,700	yes	8.31 (211.1)	1.38 (35.1)	3.64 (92.5)	4.61 (117.1)	2.30 (58.4)	1.61 (40.9)	2.39 (60.7)	2.09 (53.1)
AFRL-3	3/8"	1/4"	140	4,000	yes	7.54 (191.5)	1.57 (40.0)	1.61 (40.9)	9.37 (238.0)	3.31 (84.1)	1.97 (50.0)	2.58 (65.5)	2.76 (70.1)
AFRL-3-C	3/8"	1/4"	105	3,000	yes	10.31 (261.9)	1.57 (39.9)	4.41 (112.0)	6.06 (153.9)	3.03 (77.0)	1.97 (50.0)	2.58 (65.5)	2.76 (70.1)
AFRL-4	1/2"	1/4"	140	4,000	yes	7.54 (191.5)	1.57 (40.0)	1.61 (40.9)	9.37 (238.0)	3.31 (84.1)	1.97 (50.0)	2.58 (65.5)	2.76 (70.1)
AFRL-8	1"	1/4"	180	5,000	yes	10.69 (271.5)	1.97 (50.0)	1.89 (48.0)	11.81 (300.0)	4.13 (104.9)	2.75 (69.9)	2.97 (75.4)	3.54 (89.9)

AIR PREPARATION UNITS: BASIC FUNCTIONS

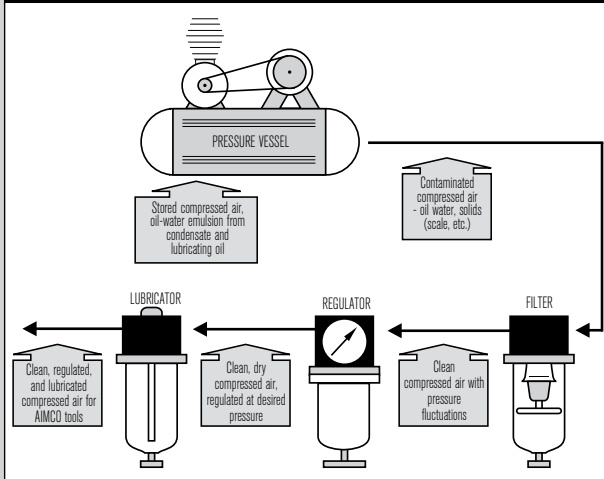

The supply of clean, dry air is essential to the operation of pneumatic powered tools. Use only clean filtered air for longer tool life. Provide proper airflow (CFM) and regulate air pressure (PSI) for optimum performance.

To determine unit size for application, you need to know:

- Total air flow (CFM) required for application
- Size of incoming air line and size of air line required by tool
- Air supply pressure (PSI)
- Allowable pressure drop
- Does the application require lubrication?
- Does the overall system have the required capacity?

GCI TORQUE REACTION ARMS

RUGGED FLEXIBILITY FOR EVEN THE MOST COMPLEX TORQUE APPLICATIONS



Carbon Fiber Arm

Constructed of durable aluminum, steel, or carbon fiber, GCI Torque Arms are available with multiple tool mounting options for application specifics. These highly ergonomic and user friendly arms are available in torque ranges of 150 Nm to 7,500 Nm and with reaches ranging up to 20 ft.

GCI arms can be designed as Smart Arms with encoders and intuitive PC-based AdaptiCS software. This complete Smart Arm system error-proofs even the most complex torque applications.

FEATURES AND BENEFITS

- Available in aluminum, steel, or carbon fiber
- Configurable installation: floor mount, wall mount, overhead mount, bench mount, or portable base
- Braking options: manual/automatic, discrete braking with verification, parking brakes, and electric/pneumatic actuation
- Tool holding options: fixed position, gimbal mount
- Integrated tool start/brake actuation capability: tool trigger start, remote tool start
- Smart Arm Capabilities:
 - Available with as many as six encoders to monitor all desirable tool positions relative to application
 - Intuitive, user-friendly AdaptiCS PC-based software that runs on an integrated industrial PC or on a customer supplied PC
 - Accepts easily scalable part images



**Rugged tablet
PC option for Smart Arm**

MODEL	MAX. TORQUE	MAX. TOOL WEIGHT	MAX. REACH	MAX. VERTICAL TRAVEL	CONSTRUCTION
IPT SERIES - TORQUES TO 375 NM					
IPT150	150 Nm	12 lb	5 ft	30 in	Aluminum
IPT375	375 Nm	50 lb	6 ft	36 in	Steel
IP SERIES - TORQUES TO 4,000 NM					
IP4	550 Nm	30 lb	8 ft	48 in	Steel
IP5	1,000 Nm	50 lb	12 ft	60 in	Steel
IP7	3,000 Nm	100 lb	12 ft	60 in	Steel
IP8T	4,000 Nm	100 lb	12 ft	72 in	Steel
F SERIES - CARBON FIBER ARMS					
F70	70 Nm	10 lb	3 ft	18 in	Carbon Fiber Composite
F600	600 Nm	50 lb	20 ft	72 in	Carbon Fiber Composite
F1500	1,500 Nm	50 lb	20 ft	72 in	Carbon Fiber Composite
F3000	3,000 Nm	75 lb	20 ft	72 in	Carbon Fiber Composite
F7500	7,500 Nm	75 lb	12 ft	72 in	Carbon Fiber Composite

GCI TORQUE REACTION ARMS

FEATURES

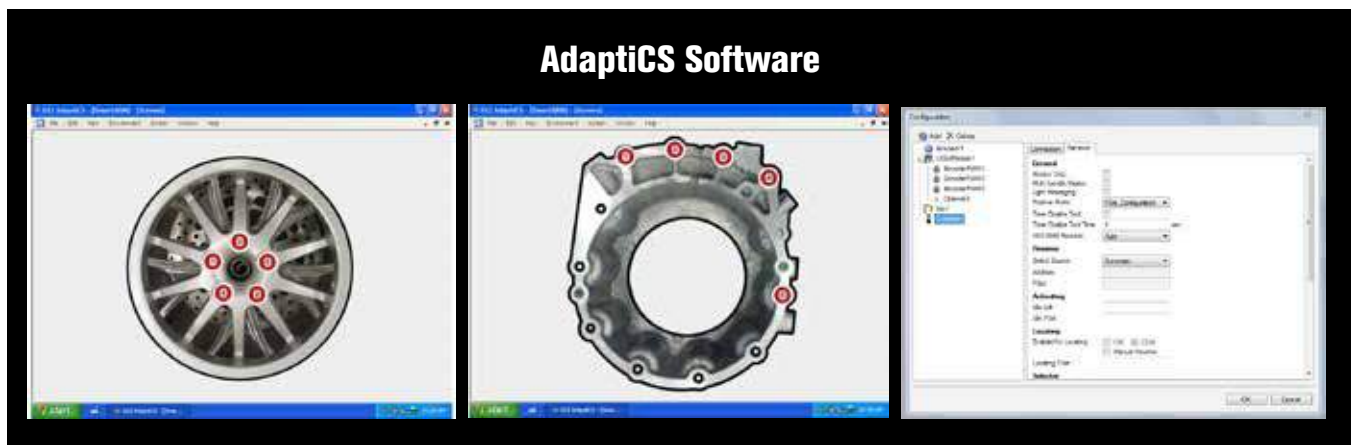

- Batch count capabilities
- Bidirectional arm articulation tracking
- Full torque/angle results display
- Integrates into any line control (PLC, MES, etc.)
- Multiple part locate strategies (1-point, 2-point, 3-point)
- Fully programmable dynamic display with integrated PC option
- Multiple rework strategies to fit customer requirements
- Integrates devices such as torque controllers via open protocol, encoded GCI torque reaction arms, scanners, vision cameras, and digital IO (pass/fail)
- AdaptiCS Enterprise (optional) provides full line control, interlocks, and data collection
- Runs on Windows 7, 8, and 10

INDEX

MODEL #	PAGE	MODEL #	PAGE	MODEL #	PAGE	MODEL #	PAGE	MODEL #	PAGE
A									
AAP1B66400A41	ABP-MTA17(Q)(WQ)(BQ)(WBQ)	37	AEH32030C(-1,2)21	AEN35090B(F)17	AEP4A(B) 7000 Series HT	
AAP1B66600A41	ABS-CTA12Q(WQ)(BQ)(WBQ)	37	AEH32040C(-1,2)21	AEN35140B(F)17	Dual-Lever Tools26
AAP1B66850A41	ABS-CTA17Q(WQ)(BQ)(WBQ)	37	AEH33042C(-1,2)21	AEN35175B(F)17	AEP4A(B) 7000 Series HT Tools	. 24
AAP1B76950A41	ABS-MTA06(Q)(WQ)(BQ)(WBQ)	37	AEH33053C(-1,2)21	AEN35225B(F)17	AEP4A(B) 8000/9000 Series	
AAP1B771350A41	ABS-MTA08(Q)(WQ)(BQ)(WBQ)	37	AEH33060C(-1,2)21	AEN35285B(F)17	HT Dual-Lever Tools26
AAP1B772000A41	ABS-MTA12(Q)(WQ)(BQ)(WBQ)	37	AEH33090C(-1,2)21	AEN35350B(F)17	AEP4A(B) 8000/9000 Series	
AAP1B772950A41	ABS-MTA17(Q)(WQ)(BQ)(WBQ)	37	AEH33120C(-1,2)21	AEN356540A25	HT Tools24
AAP1B885100A41	ABT-CTA20W	37	AEH33200C(-1,2)21	AEN3571000A25	AEP4(A)(R)(T)12003B(V)(Q)	. 16
AAP2B76250A(R)42	AED4A 7000 Series HT Tools	. 24	AEH35140B(-1,2)21	AEN3571600A25	AEP4(A)(R)(T)12006B(V)(Q)	. 16
AAP2B76450A(R)42	AED4A 8000/9000 Series		AEH35175B(-1,2)21	AEN3572600A25	AEP4(A)(R)(T)12011B(V)(Q)	. 16
AAP2B76650A(R)42	HT Tools24	AEH4F12020B(-1,2)21	AEN4C12004B14	AEP4(A)(R)(T)12014B(V)(Q)	. 16
AAP2B76950A(R)42	AED4A(B) 6000 Series HT		AEH4F12026B(-1,2)21	AEN4C12009B14	AEP4(A)(R)(T)12018B(V)	. . 16
AAP2B771400A(R)42	Tools24	AEH35090B(-1,2)21	AEN4C12014B14	AEP4(A)(R)(T)12022B(V)	. . 16
AAP2B772000A(R)42	AEF35075A(V)(VB)(-2)(B-2)	. 19	AEH35225B(-1,2)21	AEN4C12018B14	AEP4(A)(R)(T)22020B(V)	. . 16
AAP2B773000A(R)42	AEF35090A(V)(VB)(-2)(B-2)	. 19	AEH35285B(-1,2)21	AEN4C12022B14	AEP4(A)(R)(T)22025B(V)	. . 16
AAP2B785100A(R)42	AEF35110A(V)(VB)(-2)(B-2)	. 19	AEH35350B(-1,2)21	AEN4C22015BM(F)22	AEP4(A)(R)(T)22030B(V)	. . 16
AB-B1825LI38	AEF35135A(V)(VB)(-2)(B-2)	. 19	A EJ4A(B) 9X Series HT Tools	. . 24	AEN4F22030BM(F)22	AEP4(A)(R)(T)22035B(V)	. . 16
AB-B1850LI38	AEF35170A(V)(VB)19	A EJ4A(B) 9Y Series HT Tools	. . 24	AEN4F22037BM(F)22	AEP4(A)(R)(T)22040B(V)	. . 16
AB-C18-4W38	AEF35280A(B)19	A EJ4A(B) 6000 Series HT Tools	24	AEN4F22044BM(F)22	AES32010C(V)(Q)18
AB-C1811038	AEF35350A(B)19	A EJ4A(B) 7000 Series HT Tools	24	AEP35075AV(T)16	AES32020C(V)(Q)18
AB-C1822038	AEF35420A(B)19	A EJ4A(B) 8000/9000 Series HT		AEP35090AV(T)16	AES32025C(V)(Q)18
ABG860-KIT44	AEF35515A(B)19	Dual-Lever Tools26	AEP35110AV(T)16	AES32038C(V)18
ABG1400-KIT44	AEF35635A(B)19	A EJ4A(B) 8000/9000 Series		AEP35135AV(T)16	AES33040C(V)(-2)18
ABG2200-KIT44	AEF4A 6000 Series HT Tools	. 24	HT Tools24	AEP35170AV(T)16	AES33060C(V)(-2)18
ABG2800-KIT44	AEF4A 7000 Series HT Tools	. 24	AEL4A12003B(Q)14	AEP35280A(T)16	AES33100C(V)(-2)18
ABG3200-KIT44	AEF4A 8000/9000 Series HT		AEL4A12006B(Q)14	AEP35350A(T)16	AES33150CV18
ABG4100-KIT44	Tools24	AEL4A12011B(Q)14	AEP35420A(T)16	AES33230C(V)(-2)18
ABG-B185244	AEF4A(B) 8X Series HT Dual-		AEL4A12014B(Q)14	AEP35515A(T)16	AES33400C18
ABG-C11044	Lever Tools26	AEL4A12018B14	AEP35635A(T)16	AES33600C18
ABG-C22044	AEF4A(B) 6000 Series HT		AEL4A12022B14	AEP4(A)(R)(T)12006BR	. . . 23	AES35075AV18
ABN-CTA10(W)(B)(WB)	. . . 37	Dual-Lever Tools26	AEN32015C(F)(DL)17	AEP4(A)(R)(T)12011BR	. . . 23	AES35090AV18
ABN-CTA17(W)(B)(WB)	. . . 37	AEF4A(B) 7000 Series HT		AEN32025C(F)(DL)17	AEP4(A)(R)(T)12014BR	. . . 23	AES35110AV18
ABN-CTA24(W)(B)(WB)	. . . 37	Dual-Lever Tools26	AEN32030C(F)(DL)17	AEP4(A)(R)(T)12018BR	. . . 23	AES35135AV18
ABN-CTA36(W)(B)(WB)	. . . 37	AEF4A(B) 8000/9000 Series		AEN32040C(F)(DL)17	AEP4(A)(R)(T)12022BR	. . . 23	AES35170AV18
ABN-CTA55(W)(B)(WB)	. . . 37	HT Dual-Lever Tools26	AEN33042C(F)17	AEP4(A)(R)(T)22020BR	. . . 23	AES35280A18
ABN-CTA105(W)(B)(WB)	. . . 37	AEF4(A)(C)(X)12003B(B)(Q)	. 14	AEN33053C(F)17	AEP4(A)(R)(T)22030BR	. . . 23	AES35350A18
ABN-CTA130(W)(B)(WB)	. . . 37	AEF4(A)(C)(X)12006B(B)(Q)	. 14	AEN33060C(F)(DL)17	AEP4(A)(R)(T)22040BR	. . . 23	AES35420A18
ABN-MTA10(W)(B)(WB)	. . . 37	AEF4(A)(C)(X)12011B(B)(Q)	. 14	AEN33090C(F)(DL)17	AEP4A(B) 9X Series HT Tools	. 24	AES35515A18
ABP-CTA12Q(WQ)(BQ)(WBQ)	. 37	AEF4(A)(C)(X)12014B(B)(Q)	. 14	AEN33120C(F)(DL)17	AEP4A(B) 9Y Series HT Tools	. 24	AES35635A18
ABP-CTA17Q(WQ)(BQ)(WBQ)	. 37	AEF4(A)(C)(X)12018B(B)	. . . 14	AEN33200C(F)(DL)17	AEP4A(B) 6000 Series HT		AES4A 6000 Series HT Tools	. . 24
ABP-MTA08(Q)(WQ)(BQ)(WBQ)	37	AEF4(A)(C)(X)12022B(B)	. . . 14	AEN33210C(F)(DL)17	Dual-Lever Tools26	AES4A 7000 Series HT Tools	. . 24
ABP-MTA12(Q)(WQ)(BQ)(WBQ)	37	AEF35170A(-2)(B-2)19	AEN33300C(F)(DL)17	AEP4A(B) 6000 Series HT Tools	24	AES4A 8000/9000 Series HT	
		AEH32025C(-1,2)21	AEN33375C(F)(DL)17			Tools24

INDEX

MODEL #	PAGE	MODEL #	PAGE	MODEL #	PAGE	MODEL #	PAGE	MODEL #	PAGE
AES4A12003B(V)(Q)	14	ASH-500C-15MSZ	43	iEC4EGV	8	26328	29	28163	43
AES4A12006B(V)(Q)	14	ASH-500C-25MSZ	43	iEC4EV	8	26332	29	28164	43
AES4A12011B(V)(Q)	14	ASH-500Z	43	IP4	46	26336	29	28178	41, 45
AES4A12014B(V)(Q)	14			IP5	46	26337	29	28292	32
AES4A12018BV	14	B		IP7	46	26364	32	28475	35
AES4A12022BV	14	BJ10051	34	IP8T	46	26394	35	28480	28
AES4A22020BVM	22	BJ10052	34	iPC4E(1)(2)	9	26443	35	28489	34
AES4A22025BVM	22	BJ10053	34	iPC4EG(1)(2)	9	26477	29	28514	29
AES4A22030BVM	22	BJ10054	34	iPC4EGV(1)(2)	9	26478	29	28549	29
AES4A22040BVM	22	BJ10055	34	iPC4EV(1)(2)	9	26479	29	28622	35
AES4A(B) 6000 Series HT		BJ10076	29	IPT150	46	26568	35	28796	43
Dual-Lever Tools	26	BJ10077	29	IPT375	46	26570	35	28843	19
AES4A(B) 7000 Series HT		BJ10078	29			26594	32	28859	34
Dual-Lever Tools	26	F		Numbers		26630	29	30300	29
AES4A(B) 8000/9000 Series		F70	46	20322	35	26700	32	30303	29
HT Dual-Lever Tools	26	F600	46	20400	34	26709	32	30306	29
AES33150C-2	18	F1500	46	20853	35	26800	29	30340	35
AES33230C-2	18	F3000	46	21159	34	26810	29	30351	35
AET32020C(DL)	20	F7500	46	21208	35	26815	29	30355	32
AET32025C(DL)	20			21226	34	26820	29	30850	33
AET32035C(DL)	20	G		23575	35	26830	29	500-SZ	43
AET32050C(DL)	20	Gen IV ACE Controller	4	23662	35	26840	29		
AET4A12025B-KD	20	Gen IV Smart Arm System with		23730	34	26885	29		
AET4AA12018B	20	Process Visualization	12	24320	32	26890	29		
AET4AB12025B	20	I		24330	32	26934	32		
AFRL-4	41, 45	iAC4E	8	24924	35	27045	29		
AFRL-4HTA	41, 45	iAC4EG	8	25265	35	27110	32		
AFRL-2	45	iAC4EGV	8	25274	29	27115	32		
AFRL-2-C	45	iAC4ES	8	25275	29	27122	32		
AFRL-3	45	iAC4ESG	8	25276	29	27200	29		
AFRL-3-C	45	iAC4ESGV	8	25277	29	27210	32		
AFRL-8	45	iAC4ESR	8	25278	29	27255	29		
AMPST-2-I	33	iAC4ESRG	8	25289	29	27348	32		
AMPST-2-U	33	iAC4ESRGV	8	25291	29	27370	32		
AMPST-4-I	33	iAC4ESRV	8	25350	32	27594	35		
AMPST-4-U	33	iAC4ESV	8	25491	32	27768	43		
AMPST-6-I	33	iAC4EV	8	25501	35	27769	43		
AMPST-6-U	33	iBC4E	9	25518	32	27771	43		
AMPST-6S-I	33	iBC4EG	9	25646	32	27791	35		
AMPST-6S-U	33	iBC4EGV	9	25717	35	27816	35		
AMPST-8-I	33	iBC4EV	9	25718	35	28050	28		
AMPST-8-IL	33	iEC4E	8	25843	35	28161	43		
AMPST-8-U	33	iEC4EG	8	26327	29	28162	43		



PRINTED IN THE U.S.A.

LIT-AD125, REV 06-17-18, ©2019 AIMCO

AIMCO CORPORATE HEADQUARTERS

10000 SE Pine Street
Portland, Oregon 97216
Phone: (503) 254-6600
Toll Free: 1-800-852-1368

AIMCO CORPORATION DE MEXICO SA DE CV

Ave. Cristobal Colon 14529
Chihuahua, Chihuahua. 31125
Phone: (01-614) 380-1010
Fax: (01-614) 380-1019